





安全注意事项 Safety precautions

为确保安全使用本产品，必须遵守下列安全标志，以免伤害人员，损坏设备。To ensure the safe use of this product, the following safety signs must be observed so as to avoid damage to personnel or equipment.

 警告 Notice	表示错误操作可引发危险，导致轻度或中度人身伤害，损坏设备，甚至引发火灾。Indicates that an error operation can cause danger, mild or moderate bodily harm, damage to equipment, or even fire.
 危险 Danger	表示错误操作引发危险，导致伤害或死亡。Represents an error operation that raises danger, causing injury or death.
	表示禁止操作。Inhibit operation.
	表示必须操作。Indicates that operations must be performed.

产品到达后，进行确认、安装、配线、运行维护、检查时，以下是必须遵守的重要事项：After the arrival of the product, the following important matters must be observed when confirming, installing, wiring, running, maintaining and checking the products:

● 安装时注意事项：Notes on installation:

 警告 Notice
<p>严禁安装在潮湿及会发生腐蚀的环境、有易燃性气体的环境下、可燃物的附近及灰尘、金属粉末较多的环境，否则有可能会发生触电和火灾。It is strictly prohibited to install in humid and corrosive environment, flammable gas environment, near combustibles and dust, metal powder environment, otherwise there may be electric shock and fire.</p>

● 配线时的注意事项：Precautions for wiring:

 警告 Notice
<ul style="list-style-type: none"> ▲ 伺服驱动器的接地端子必须接地，否则，可能会发生触电和火灾。 The ground terminal of the servo driver must be earthed. Otherwise, an electric shock and fire may occur. ▲ 严禁把伺服驱动器的输出端子U, V, W，连接至三相电源，否则，可能受伤和引发火灾。 Strictly prohibit the servo driver output terminals U, V, W connected to three-phase power supply, otherwise it may hurt and cause fire. ▲ 严禁把220V驱动器连接至380V电源，否则可以触电和引发火灾。 220V drive is strictly prohibited to connect to the 380V power supply, otherwise you can get an electric shock and a fire. ▲ 务必将电源端子、电机输出端子拧紧，否则有可能会引发火灾。 Make sure the power terminals and motor terminals are tightened, or there may be a fire.

●运行时的注意事项：Considerations for runtime:

 危险 Danger
<ul style="list-style-type: none">▲ 在运行中，严禁触摸任何旋转部件，否则可能会受伤。In operation, it is strictly forbidden to touch any rotating parts, or you may be injured.▲ 在运行中，严禁触摸电机和驱动器，否则可能会烫伤。In operation, do not touch the motor and drive, or you may be burned.

 警告 Notice
<ul style="list-style-type: none">▲ 在运行前，必须选择好正确的电机型号，否则可能人员受到伤害，损伤设备。Before running, you must select the correct motor type, otherwise, may be injured, damage to equipment.▲ 在运行前，必须设置好与应用场合相适应的用户参数，否则可能受到伤害，损伤设备。Before running, you must set the user parameters that suit the application. Otherwise, you may be harmed and damage the equipment.▲ 在运行前，确认机械是否可随时紧急停止，否则，可能会受伤。Before running, make sure that the machine can be stopped at any time, or you may get injured.

●保养检查时的注意事项：Precautions for maintenance and inspection:

<ul style="list-style-type: none">▲ 严禁触摸伺服驱动器的内部，否则有可能触电。Do not touch the inside of servo drive, or you may get an electric shock.▲ 关闭电源后，在5分钟内，严禁触摸端子，否则，残留的电压可能会导致触电。After closing the power supply, it is strictly forbidden to touch the terminal within 5 minutes. Otherwise, the residual voltage may cause an electric shock.▲ 严禁拆装伺服电机，否则有可能触电。Disassembly servo motor is not allowed, otherwise it is possible to get an electric shock.

目录 Catalog

第 1 章产品检查及安装 The first chapter: product inspection and installation ...	1 -
1.1 产品检查 Product inspection	1 -
1.2 产品铭牌 id label	2 -
1.3 产品前面板 Product front panel	3 -
1.4 驱动器技术规格 Driver specification	4 -
1.5 伺服电机安装 Servo motor installation	7 -
1.6 电机旋转方向 Motor rotation direction	8 -
1.7 伺服单元与电机型号适配 Servo unit and motor model adaptation	8 -
第 2 章接线 The second chapter wiring	11 -
2.1 系统组成与接线 System composition and connection	11 -
2.1.1 220V 伺服驱动器接线图 220V servo driver wiring diagram	11 -
2.1.2 380V 伺服驱动器接线图 380V servo driver wiring diagram	12 -
2.1.3 接线说明 Wiring instructions	13 -
2.1.4 电线规格 Wire specification	14 -
2.1.5 强电端子说明 Strong terminal description	14 -
2.2 CN1 通信接口 CN1 communication interface	16 -
2.3 CN2 控制接口 CN2 control interface	17 -
2.4 CN3 编码器接口 CN3 encoder interface	27 -
2.3 标准接线 Standard connection	29 -
2.3.1 位置控制接线图(标准版) Position control wiring diagram (Standard Version)	29 -
2.3.2 位置控制接线图(进阶版) Position control wiring diagram (Advanced Edition)	30 -

2.3.3 速度/转矩控制接线图(标准版) Speed / torque control wiring diagram (Standard Version)	31 -
2.3.4 速度/转矩控制接线图(进阶版) Speed / torque control wiring diagram (Advanced Edition)	32 -
第 3 章显示与操作 The third chapter shows and operates	- 33 -
3.1 面板组成 Panel composition	- 33 -
3.1.1 显示屏与按键(标准版) Display and button (Standard Edition)	- 33 -
3.1.2 显示屏与按键(进阶版) Display and button (Advanced Edition)	- 34 -
3.2 模式功换 Mode work change	- 34 -
3.3 监控模式(Dn)操作 Monitoring mode (Dn) operation	- 35 -
3.4 辅助模式(Fn)操作 Auxiliary mode (Fn) operation	- 36 -
3.5 用户参数模式(Pn)操作 User parameter mode (Pn) operation	- 46 -
第 4 章 Pn 功能参数 The fourth chapter, Pn function parameter	- 48 -
4.1 参数设置面板操作 Parameter settings panel action	- 48 -
4.2 参数一览表 Parameter list	- 48 -
4.2.1 系统控制参数 System control parameter	- 48 -
4.2.2 位置控制参数 Position control parameter	- 54 -
4.2.3 速度控制参数 Speed control parameter	- 58 -
4.2.4 转矩控制参数 Torque control parameter	- 61 -
4.2.5 扩展控制参数 Extended control parameter	- 63 -
4.3 参数详解 Parameter detail	- 66 -
4.3.1 系统参数 system parameter	- 66 -
4.3.2 位置控制参数 Position control parameter	- 102 -

4.3.3 速度控制参数 Speed control parameter.....	- 115 -
4.3.4 转矩控制参数 Torque control parameter.....	- 125 -
4.3.5 扩展控制参数 Extended control parameter.....	- 134 -
4.4 端口功能详解 Port function detail	- 140 -
4.4.1 SigIn 输入端口功能详解 SigIn input port function detailed.....	- 140 -
4.4.2 SigOut 输出端口功能详解 SigOut output port function detailed.....	- 145 -
第 5 章 监控参数与操作 The fifth chapter monitoring parameters and operation... -	148 -
5.1 监控面板操作 Monitor panel operation.....	- 148 -
5.2 监控参数一览表 List of monitoring parameters	- 148 -
第 6 章 报警及处理 The sixth chapter, alarm and treatment.....	- 150 -
6.1 报警清除操作 Alarm clearing operation	- 150 -
6.2 警报内容与对策 Alert content and Countermeasures	- 150 -
6.3 其它故障现象及处理措施 Other fault phenomena and treatment measures ..	- 160 -
第 7 章 Modbus 串口通信 The seventh chapter is Modbus serial communication . -	164 -
7.1 Modbus 通信简介 Introduction to Modbus Communications	- 164 -
7.1.1 编码含义 Coding meaning	- 164 -
7.1.2 数据结构 data structure	- 165 -
7.2 通信协议结构 Communication protocol architecture	- 166 -
7.3 常用命令码 Common command code	- 167 -
7.3.1 读多个寄存器 Read multiple registers	- 167 -
7.3.2 写单个寄存器 Write single register.....	- 169 -

7.3.3 诊断 Diagnosis	- 171 -
7.3.4 写多个寄存器 Write multiple registers	- 173 -
7.3.5 校验码计算 Check code calculation.....	- 177 -
7.3.6 异常码 Exception code.....	- 180 -
7.4 伺服参数、状态信息通信地址 Servo parameter, status information, communication address	- 181 -
第 8 章运行与调整 The eighth chapter, operation and adjustment	- 182 -
8.1 点动运行 Inching operation	- 182 -
8.2 按键调速运行 Push-button speed control.....	- 183 -
8.3 增益调谐 Gain tuning	- 183 -
8.3.1 系统惯量识别 System inertia identification	- 184 -
8.3.2 自动增益调整 Automatic gain adjustment	- 187 -
8.3.3 手动增益调整 Manual gain adjustment	- 188 -
8.3.4 抑制抖动方法 Jitter suppression method	- 190 -
第 9 章伺服单元控制结构与实例 The ninth chapter, servo unit control structure and example	- 191 -
9.1 位置控制实例 Position control example	- 191 -
9.1.1 位置控制结构图 Position control structure diagram	- 191 -
9.1.2 位置控制举例 Example of position control	- 191 -
9.2 速度控制实例 Example of speed control.....	- 191 -
9.2.1 速度控制结构图 Speed control structure diagram	- 192 -
9.2.2 速度控制举例 Example of speed control	- 192 -
9.3 转矩控制实例 Torque control example	- 192 -

9.3.1 转矩控制结构图 Torque control structure diagram.....	192 -
9.3.2 转矩控制举例 Example of torque control	193 -
9.4 电子齿轮比计算 Electronic gear ratio calculation.....	193 -
9.5 电子齿轮比举例 Example of electronic gear ratio	195 -
9.5.1 滚珠丝杆 ball screw	195 -
9.5.2 圆台 Round table.....	196 -
9.5.3 皮带+皮带轮 Belt + pulley	196 -
第 10 章绝对式伺服单元的使用 The tenth chapter, the use of absolute servo unit	198 -
10.1 绝对数据信息输出方式 Absolute data output mode.....	198 -
10.2 绝对数据信息收发时序 Absolute data transceiver timing	199 -
10.3 ABZ 脉冲信号分频输出 ABZ pulse frequency division output	204 -
10.4 绝对式编码器的初始化 Initialization of absolute encoder	204 -
10.5 绝对式编码器电池的安装 Installation of absolute encoder batteries	205 -
附录 appendix	206 -
附录 A 增益切换 Appendix A gain switching.....	206 -
附录 B 控制模式切换 Appendix B control mode switching.....	207 -
B.1 位置/速度控制模式切换 Position / speed control mode switching	207 -
B.2 位置/转矩控制模式切换 Position / torque control mode switching	208 -
B.3 速度/转矩控制模式切换 Speed / torque control mode switching	210 -
附录 C 伺服驱动器工作时序 Appendix C servo drive operation timing	210 -
C.1 电机静止时的 ON/OFF 动作时序 ON/OFF timing of motors at rest	210 -

C.2 电机运转时的 ON/OFF 动作时序 ON/OFF timing of motor operation	- 211 -
C.3 伺服 ON 时报警的时序 Timing of alarm when servo ON	- 211 -
附录 D 电磁制动器 Appendix D electromagnetic brake	- 212 -
附录 E 再生制动电阻 Appendix E regenerative braking resistor	- 212 -
附录 F 原点回归 Appendix F origin regression	- 214 -
F1.1 原点回归运行步骤 Origin regression operation step	- 214 -
F1.2 原点回归触发时序 Origin regression trigger timing	- 215 -
F1.3 原点回归组合模式时序 Origin regression, combination model, time series	- 217 -
附录 G 内部位置控制 Appendix G internal position control	- 222 -
附录 H 定长位移中断 Appendix H fixed length displacement interruption	- 224 -

第 1 章 产品检查及安装

The first chapter: product inspection and installation

1.1 产品检查 Product inspection

本产品出厂前均做过完整功能测试，为防止产品运送过程中因疏忽导致产品不正常，拆封后请详细检查下列事项：The products in the factory have done a complete functional test, in order to prevent the process of transporting products caused by negligence are not normal, please check the following items after unpacking:

- 检查伺服驱动器与伺服电机型号是否与订购的机型相同。Check whether servo drive and servo motors are the same as those ordered.
- 检查伺服驱动器与伺服电机外观有无损坏及刮伤现象。运送中造成损伤时请勿接线送电。Check the servo driver and servo motor for damage and scratching. Please do not wire or send electricity when causing damage in transit.
- 检查伺服驱动器与伺服电机有无零件松脱之现象。是否有松脱的螺丝，是否螺丝未锁紧或脱落。Check that the servo drive and servo motor are loose or loose. Is there a loose screw, whether the screws are not locked or broken.
- 检查伺服电机转子轴是否能以手平顺旋转。带制动器的电机无法直接旋转。Check that the rotor shaft of the servo motor can rotate smoothly by hand. The motor with the brake can not be rotated directly.

如果上述各项发生故障或有不正常的现象，请立即与经销商联系。If any of the above is out of order or abnormal, please contact the distributor immediately.

1.2 产品铭牌 id label



Danger: Please follow the instructions, installation, wiring and use, be sure to reliably grounding

High-voltage power supply: Please don't disassemble the driver during the 5 minutes when the power is on and the power is cut off, so as to prevent electric shock

1.3 产品前面板 Product front panel

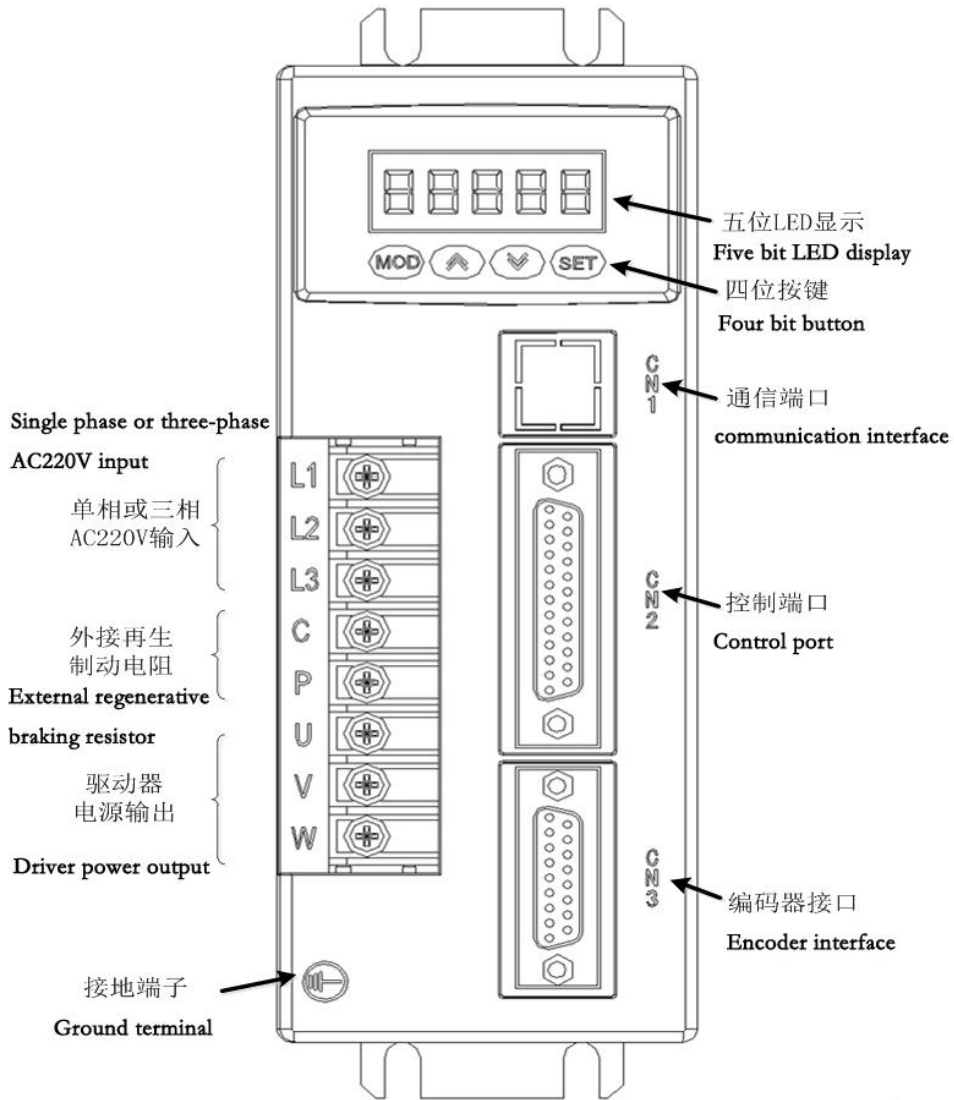

1.4 驱动器技术规格 Drive specification

输入电源 Input power		① 单相或三相AC220V -15~+10% 50 / 60Hz Single phase or three-phase AC220V -15 to +10% 50 / 60Hz ②单相或三相AC380V -15~+10% 50 / 60Hz Single phase or three-phase AC380V -15 to +10% 50 / 60Hz
环境 environment	温度 temperature	工作: 0~55 °C 存贮: -20°C~80°C Work: store at 0~55 DEG C: -20 ~ 80 DEG C
	湿度 humidity	小于90% (无结露) Less than 90% (without condensation)
	振动 Vibration	小于0.5G(4.9m/S ²), 10~60Hz (非连续运行) Less than 0.5G (4.9m/S ²), 10 to 60Hz (non continuous running)
控制方式 control mode		IGBT PWM 正弦波控制 power pwm 正弦波控制
控制模式 control model		① 转矩模式(内部或外部) Torque mode (internal or external) ④位置/速度模式 Position / speed mode ②速度模式(内部或外部) Speed mode (internal or external) ⑤位置/转矩模式 Position / torque model ③位置模式(内部或外部) Location mode (internal or external) ⑥速度/转矩模式 Speed / torque mode
控制输入 control input		伺服使能、报警复位、正转驱动禁止、反转驱动禁止、 外部正转转矩限制、外部反转转矩限制、紧急停机、 零速箝位、内部速度指令选择 1、内部速度指令选择 2 内部速度指令选择 3、内部转矩指令选择 1、 内部转矩指令选择 2、控制模式切换、增益切换、 电子齿轮分子选择 1、电子齿轮分子选择 2、指令取反、 位置偏差清除、脉冲输入禁止、比例控制、原点回归触发、 原点回归参考点、内部位置选择 1、内部位置选择 2、 触发内部位置指令、暂停内部位置指令、内外部位置指令选择 定长位移中断、定长解锁 Servo enable, alarm reset, forward drive, inhibit and reverse drive prohibited, External forward torque limit, external reverse torque limit, emergency stop, Zero speed clamp, internal speed command select 1, internal speed command select 2Internal speed command select 3, internal torque command select 1, Internal torque command select 2, control mode switching, gain switching, The choice of the electronic gear molecule 1, the electronic gear molecule selection 2, the

	instruction counter, The position deviation is cleared, the pulse input is forbidden, the proportional control and the origin return trigger, Origin regression reference point, internal position selection 1, internal position selection 2, Trigger an internal position instruction, pause an internal position command, and select an internal and external position commandFixed length, displacement interruption, fixed length unlocking
控制输出 Control output	报警检出、伺服准备好、紧急停止检出、定位完成、速度到达、到达预定转矩、零速检测、伺服电机通电、电磁制动、原点回归完成、定位接近、转矩限制中、速度限制中、 跟踪转矩指令到达 Alarm detection, servo ready, emergency stop detection, positioning completed, Speed arrives, arrives at the predetermined torque, the zero speed examination, the servo motor electrify, Electromagnetic brake, origin return, position approach, torque limit, speed limit, Tracking torque command arrives
编码器反馈 Encoder feedback	① 2500线增量式编码器2500 line incremental encoder ②17位绝对式编码器17 bit absolute encoder
通信方式 communication mode	① RS-232 ②RS-485
显示与操作 Display and operation	① 5位LED显示5 LED display ②4/5个按键4/5 keys
制动方式 Braking mode	通过内置/外接制动电阻进行能耗制动 Energy consumption braking by built-in / external braking resistor
冷却方式 Cooling method	风冷（热传导模具、高速强冷风扇） Air cooling (heat conduction mould, high speed strong cooling fan)
功率范围 Power range	≤10KW

1.5 伺服电机安装 Servo motor installation

安装环境条件 Installation environment condition

- 工作环境温度：0~40℃；工作环境湿度：80%以下（无结露）。Working environment temperature: 0~40 degrees centigrade; working environment temperature: 80% below (without dew).
- 贮存环境温度：-40~50℃；贮存环境湿度：80%以下（无结露）。Storage environment temperature: -40 ~ 50 degrees; storage environment humidity: less than 80% (without condensation).
- 振动：0.5G 以下。Vibration: 0.5G below.
- 通风良好、少湿气及灰尘之场所。Well ventilated place with little moisture and dust.
- 无腐蚀性、引火性气体、油气、切削液、铁粉等环境。non corrosive, fire gases, oil and gas, cutting fluid, iron powder and so on.
- 无水汽及阳光直射的场所。no water vapor and direct sunlight.

安装方法 Installation method

- 水平安装：为避免水、油等液体自电机出线端流入电机内部，请将电缆出口置于下方。horizontal installation: to avoid water, oil and other liquids from the motor outlet end into the motor, please put cable outlet below.
- 垂直安装：若电机轴朝上安装且附有减速机时，须注意并防止减速机内的油渍经由电机轴渗入电机内部。Vertical mounting: if the motor shaft is mounted upwards and attached to the reducer, attention shall be paid to preventing the grease in the reducer from penetrating into the motor through the motor shaft.
- 电机轴的伸出量需充分，若伸出量不足时将容易使电机运动时产生振动。The extension of the motor shaft needs to be sufficient. If the amount of the extension is insufficient, it will vibrate easily when the motor is moving.

- 安装及拆卸电机时，请勿用榔头敲击电机，否则容易造成电机轴及编码器损坏。The installation and disassembly of the motor, with a hammer percussion motor do not, otherwise easy to cause damage to the motor shaft and the encoder.

1.6 电机旋转方向 Motor rotation direction

从电机负载端看，电机轴伸逆时针旋转（CCW）为正转，顺时针旋转（CW）为反转。

From the motor load side, the motor shaft extends counterclockwise (CCW) for the positive rotation, and the clockwise rotation (CW) is reversed.

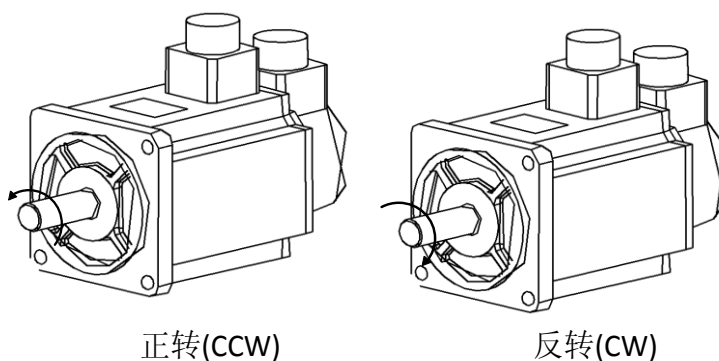

1.7 伺服单元与电机型号适配 Servo unit and motor model adaptation

220V 驱动器型号与电机型号适配表如下： The 220V drive model and the motor model adaptation sheet are as follows:

电机型号 Motor model	Pn001	额定转速 Rated speed (r/min)	额定转矩 Rated torque (N.M)	额定功率 Rated power (KW)	KRS 15	KRS 20A	KRS 30A	KRS 50A	KRS 75A
60st_m00630	0	3000	0.6	0.2	√	√	√		
60st_m01330	1	3000	1.3	0.4	√	√	√		
60st_m01930	2	3000	1.9	0.6	√	√	√		
80st_m01330	3	3000	1.3	0.4	√	√	√		
80st_m02430	4	3000	2.4	0.75	√	√	√		
80st_m03520	5	2000	3.5	0.73	√	√	√		

80st_m04025	6	2500	4	1	√	√	√		
90st_m02430	7	3000	2.4	0.75	√	√	√		
90st_m03520	8	2000	3.5	0.73	√	√	√		
90st_m04025	9	2500	4	1	√	√	√		
110st_m02030	10	3000	2	0.6	√	√	√		
110st_m04020	11	2000	4	0.8	√	√	√		
110st_m04030	12	3000	4	1.2		√	√		
110st_m05030	13	3000	5	1.5			√		
110st_m06020	14	2000	6	1.2	√	√	√		
110st_m06030	15	3000	6	1.8			√		
130st_m04025	16	2500	4	1	√	√	√		
130st_m06015	17	1500	6	1	√	√	√		
130st_m05025	18	2500	5	1.3		√	√		
130st_m06025	19	2500	6	1.5			√		
130st_m07725	20	2500	7.7	2			√		
130st_m10010	21	1000	10	1	√	√	√		
130st_m10015	22	1500	10	1.5		√	√		
130st_m10025	23	2500	10	2.6			√	√	√
130st_m15015	24	1500	15	2.3			√		
130st_m15025	25	2500	15	3.8				√	√
150st_m15025	26	2500	15	3.8				√	√
150st_m15020	27	2000	15	3				√	√
150st_m18020	28	2000	18	3.6				√	√
150st_m23020	29	2000	23	4.7				√	√
150st_m27020	30	2000	27	5.5					√
180st_m17215	31	1500	17.2	2.7				√	√
180st_m19015	32	1500	19	3			√	√	√
180st_m21520	33	2000	21.5	4.5				√	√
180st_m27010	34	1000	27	2.9				√	√
220st_m67010	35	1000	67	7					√
180st_m35015	37	1500	35	5.5					√
40st_m00330	39	3000	0.3	0.1	√	√	√		

380V 驱动器型号与电机型号适配表如下：

The 380V drive model and the motor model adaptation sheet are as follows:

电机型号 Motor model	Pn001	额定转速 Rated speed (r/min)	额定转矩 Rated torque (N.M)	额定功率 Rated power (KW)	KRS 25	KRS 40	KRS 50	KRS 75
180st_m48020	46	2000	48	10			√	√
180st_m19020	47	2000	19	4		√	√	√
180st_m35020	48	2000	35	7.3		√	√	√
180st_m27020	49	2000	27	5.6		√	√	√
180st_m48015	50	1500	48	7.5			√	√
180st_m19015	51	1500	27	3		√	√	√
180st_m21520	52	2000	27	4.5		√	√	√
180st_m27010	53	1000	27	2.9		√	√	√
180st_m27015	54	1500	27	4.3		√	√	√
180st_m35010	55	1000	35	3.7		√	√	√
180st_m35015	56	1500	35	5.5		√	√	√

第 2 章接线 The second chapter wiring

2.1 系统组成与接线 System composition and connection

2.1.1 220V 伺服驱动器接线图 220V servo drive wiring diagram

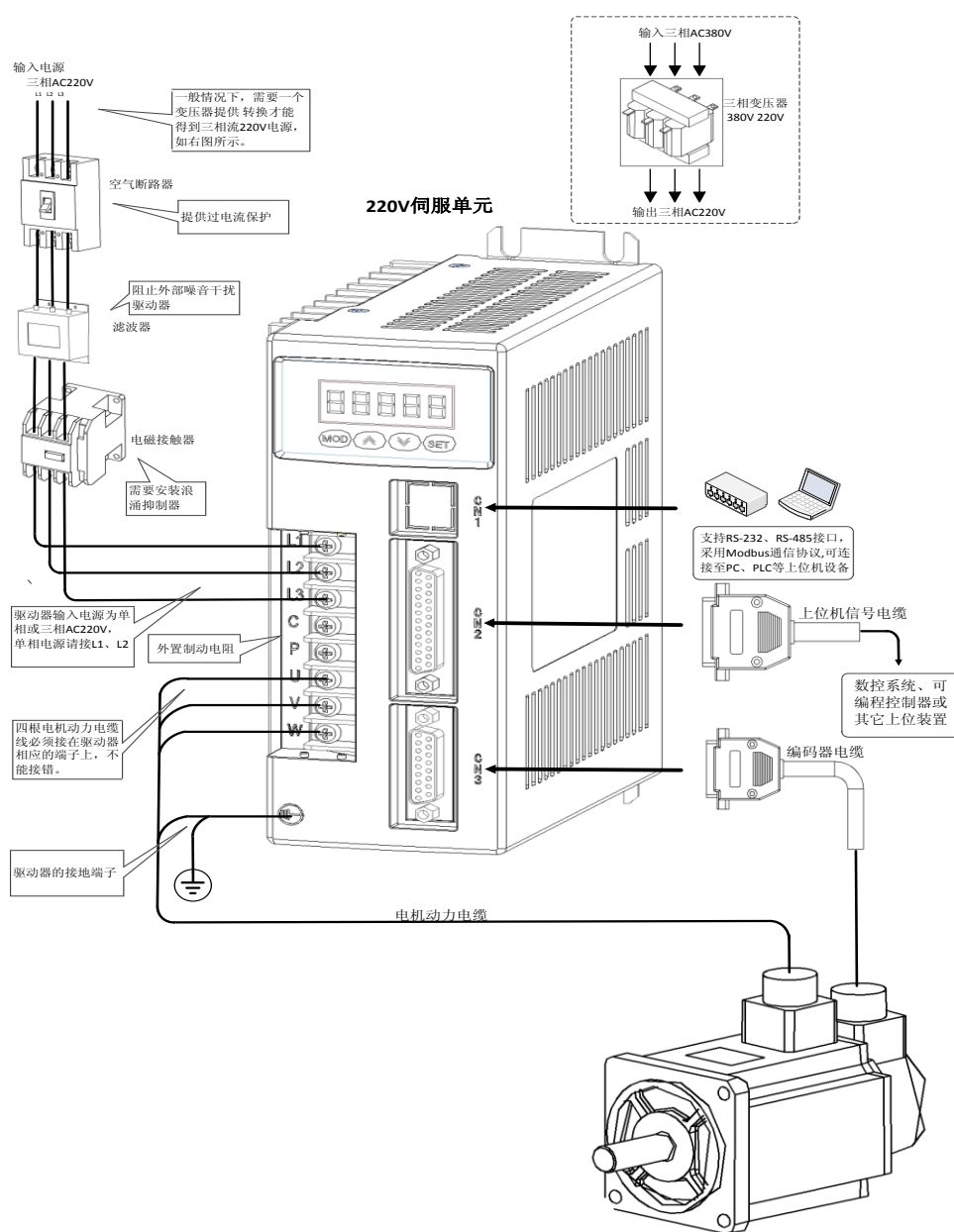

2.1.2 380V 伺服驱动器接线图 380V servo drive wiring diagram

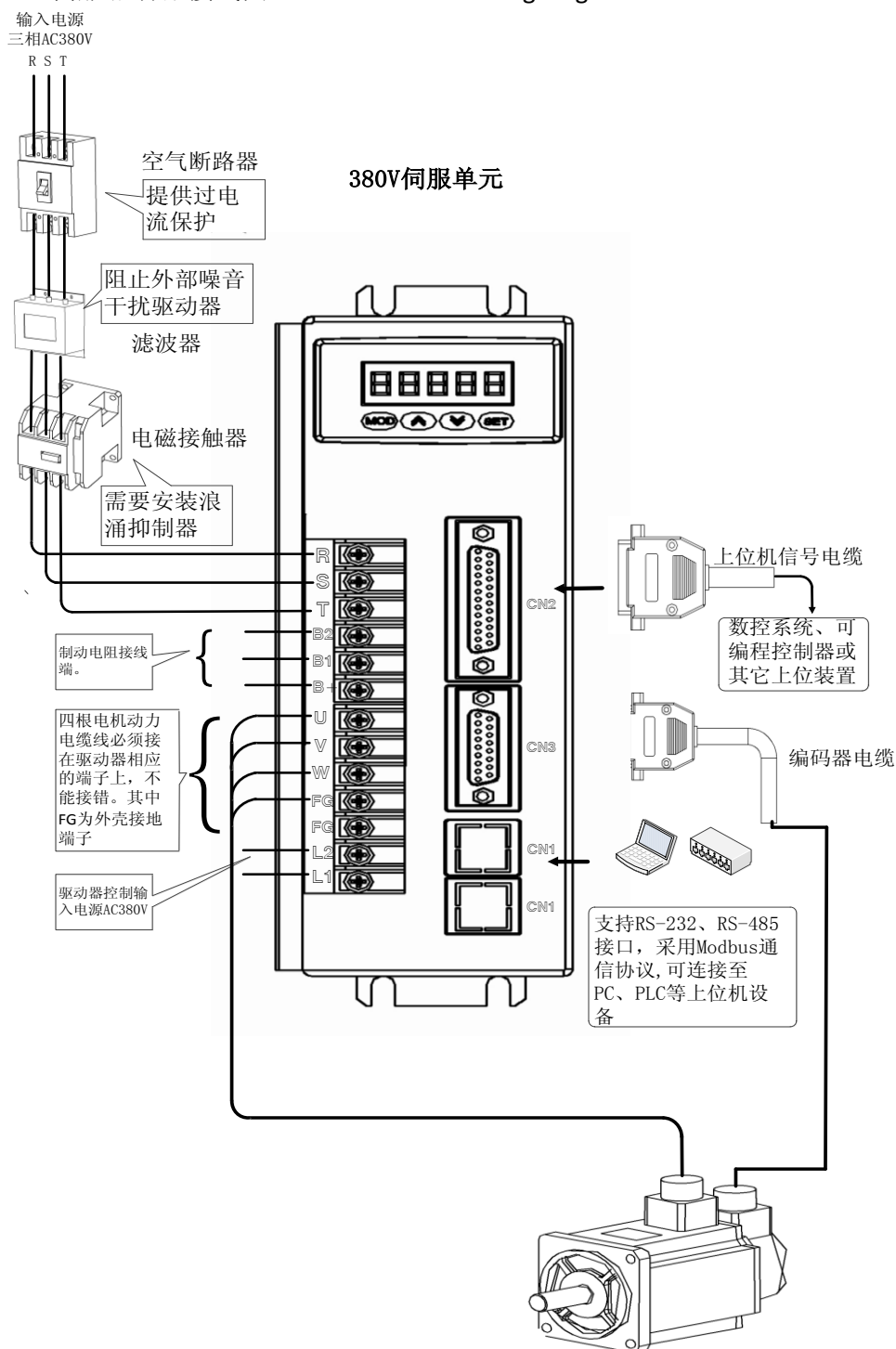

2.1.3 接线说明 Wiring instructions

接线注意事项: Wiring notes:

- 接线材料依照电线规格使用。Wiring materials are used in accordance with wire specifications.
- 电缆长度, 指令电缆 3m 以内, 编码器电缆 20m 以内。Cable length, instruction cable 3M, less than 20m of encoder cable.
- 220v 驱动器电源 L1、L2、L3 电源接线是否正确, 请勿接到 380V 电源上。The 220V drive power L1, L2, L3 power supply wiring is correct, please do not connect to the 380V power supply.
- 380v 驱动器电源 R、S、T 电源接线是否正确, 请勿接到 220V 电源上, 否则电机运转不正常。
控制电源 L1, L2 必须正常接入, 否则驱动器无法开机运行。The 380V drive power R, S, T power supply wiring is correct, please do not connect to the 220V power supply, otherwise the motor is not functioning properly. Control power L1, L2 must be normal access, otherwise the drive can not start running.
- 电机输出 U、V、W 端子相序, 必须和电机相应端子一一对应。若接错, 电机可能不转或飞车, 损坏驱动器。不能用调换三相端子的方法来使电机反转, 这一点与异步电机完全不同。Motor output U, V, W terminals phase sequence, and the corresponding terminals must correspond to the motor. If the connection is wrong, the motor may not turn or drive, damaging the drive. The motor can not be reversed by replacing the three-phase terminal, which is quite different from the asynchronous motor.
- 必须可靠接地, 而且单点接地。must be reliable grounded and single point grounding.
- 装在输出信号的继电器, 其吸收用的二极管的方向要连接正确, 否则会造成故障无法输出信号。The relay that is mounted on the output signal must be connected correctly in the direction of the diode it is used for, otherwise it will cause a fault and cannot output the signal.
- 为了防止噪声造成的错误动作, 请在电源上加入绝缘变压器及噪声滤波器等装置在同一配线管内。
in order to prevent the error caused by noise, please add the insulation transformer and noise filter on the power supply in the same wiring tube.
- 请安装非熔断型断路器使驱动器故障时能及时切断外部电源。Please install non fusing circuit breaker so that the driver can cut off the external power supply in time.

2.1.4 电线规格 Wire specification

连接端子 Connection terminal	符号 Symbol	电线规格 Wire specification
电源线 Power cord	U、V、W	0.75~2.5mm ²
电机连接端子 Motor connecting		0.75~2.5mm ²
接地端子 Ground terminal		0.75~2.5mm ²
控制信号端子 Control signal	C N 2	≥0.12 mm ² (AWG26), 含屏蔽线 Shielded wire
编码器信号端子 Encoder signal	C N 3	≥0.12 mm ² (AWG26), 含屏蔽线 Shielded wire

编码器电缆必须使用双绞线。如果编码器电缆太长 (>20m)，会导致编码器供电不足，其电源和地线可采用多线连接或使用粗电线。The encoder cable must be twisted pair. If the encoder cable is too long (>20m), the encoder will have insufficient power supply, and the power and ground can be connected by multiple wires or using a thick wire.

2.1.5 强电端子说明 Strong terminal description

● 220V 驱动器端子 220V drive terminals

名称 Name	端子符号 Terminal symbol	详细说明 Detailed description
主电路电源 Main circuit power supply	L1、L2、L3	连接外部交流电源三相 220VAC -15%~+10% 50/60Hz 单相电源须接 L1、L2 端子 Connect external AC power, three-phase 220VAC -15% to +10% 50/60Hz The single-phase power supply shall be connected to the L1 and L2 terminals
电机连接端子 Motor connecting terminal	U	输出到电机 U 相电源 Output to the motor U phase power supply
	V	输出到电机 V 相电源 Output to the motor V phase power supply
	W	输出到电机 W 相电源 Output to the motor W phase power supply
接地端子 Ground terminal		电机外壳接地端子 Motor housing earthing terminal
		驱动器接地端子 Driver ground terminal

● 380V 驱动器端子 380V drive terminals

名称 Name	端子符号 Terminal symbol	详细说明 Detailed description
控制电路电源 Control circuit power supply	L1、L2	连接外部交流电源 三相 380VAC -15%~+10% 50/60Hz Connect an external AC power supply Three-phase 380VAC -15% to +10% 50/60Hz
制动电阻接线端子 Braking resistor terminal	B1、B2、B+	若使用内部制动电阻，须短接 B2, B1; If internal braking resistor is used, short B2, B1 shall be used 若使用外部制动电阻，须拆去 B2, B1 端子间的连线，安装制动电阻接在 B2, B+端子上。If an external braking resistor is used, the connections between the B2 and B1 terminals must be removed, and the brake resistance shall be mounted on the B2 and B+ terminals.
电机连接端子 Motor connecting terminal	U	输出到电机 U 相电源 Output to the motor U phase power supply
	V	输出到电机 V 相电源 Output to the motor V phase power supply
	W	输出到电机 W 相电源 Output to the motor W phase power supply
接地端子 Ground terminal	FG	电机外壳接地端子 Motor housing earthing terminal
	FG	驱动器接地端子 Driver ground terminal

2.2 CN1 通信接口 CN1 communication interface

2.2.1 CN1 端口信号定义(标准版) CN1 port signal definition (Standard Version)

名称 Name	引脚号 Pin number	功能 function
+5V	2	5V
GND	5	地 ground
Tx	1	RS-232 发送端 Sending end
Rx	3	RS-232 接收端 receiving end
A	4	RS-485 A
B	6	RS-485 B



2.2.2 CN1 端口信号定义(进阶版) CN1 port signal definition (Advanced Edition)

名称 Name	引脚号 Pin number	功能 function
RS485+	1	RS-485 A
空	2	
RS485-	3	RS-485 B
RX232_TX	4	RS-232 发送端 Sending end
RX232_RX	5	RS-232 接收端 receiving end
GND	6	地 ground
FG	7	外壳地 Motor housing ground
+5V	8	5V



2.2.3 CN1 端口类型 CN1 port type

1. RS-232 接口 RS-232 interface

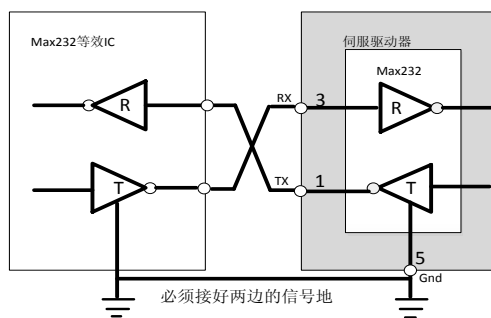

2. RS-485 接口 RS-485 interface

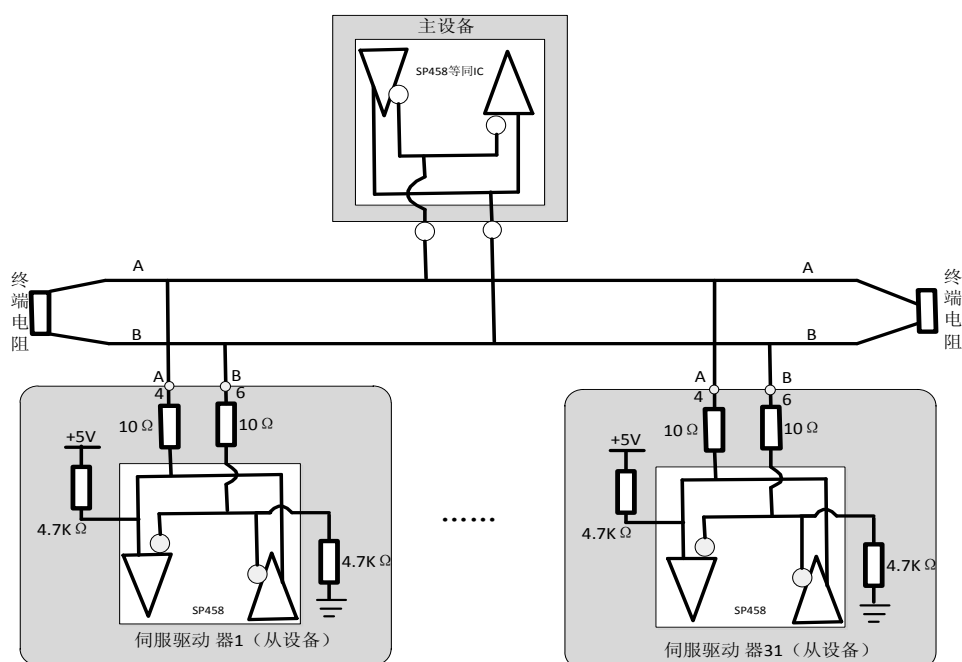

● 采用 RS485 通信时，最多可同时连接 31 台伺服驱动器，485 网络末端需分别接一个 120 欧电阻的终端电阻。若欲连接更多的设备，必须用中继器来扩展连接的台数。When using RS485 communication, at most 31 servo drivers can be connected at the same time, and 485 terminals of the network need to be connected with a terminal resistor of 120 ohm respectively. To connect more devices must be used to expand the number of connected repeaters.

2.3 CN2 控制接口 CN2 control interface

CN2 控制信号端子提供与上位控制器边接所需要的信号,使用 DB25 可 DB44 插座,信号包括: The CN2 control signal terminal provides the signal needed for the connection with the upper controller, and uses the DB25 DB44 socket:

- 4 个可编程输入(标准版), 10 个可编程输入(进阶版): 4 programmable inputs (Standard Version), 10 programmable inputs (advanced version);
- 4 个可编程输出(标准版), 5 个可编程输出(进阶版): 4 programmable outputs (Standard Version), 5 programmable outputs (Advanced Edition);
- 模拟量指令输入: Analog command input;
- 脉冲指令输入: Pulse command input;
- 编码器信号输入: Encoder signal input;
- 编码器分频输出信号: Encoder frequency division output signal;

2.3.1 CN2 端口信号定义(标准版) CN2 port signal definition (Standard Version)

引脚 Pin	接口编号 Interface number	名称 Name	功能 function
DC12~24V COM	9 10	控制信号的电源 与地 The power and ground of the control signal	输入输出控制信号的输入电源和地 The input and output control signals are input power and ground
SigIn1 SigIn2 SigIn3 SigIn4	6 7 21 8	输入指令信号 Input instruction signal	输入指令信号。出厂时各个输入信号端 口指定的功能: Input instruction signal. The function specified by each input port at the factory: SigIn1: 伺服使能 Servo enable SigIn2: 报警复位 Alarm reset SigIn3: 位置偏差清除 Clearance of position deviation SigIn4: 脉冲输入禁止 Pulse input inhibit
SigOUT1 SigOUT2 SigOUT3 SigOUT4	11 23 12 24	输出指令信号 Output instruction signal	输出指令信号。出厂时各个输出信号端 口指定的功能: Output instruction signal. The function specified by each output signal port at the factory: SigOUT1: 伺服准备好 Servo enable SigOUT2: 报警检出 Alarm detection SigOUT3: 定位完成 Location complete SigOUT4: 紧急停止检出 Emergency stop detection
PV PP+ PP- PD+	2 3 14 4	指令脉冲输入端 口 Command pulse input port	PV: 集电极开路输入电源 PV: open collector input power 指令脉冲可以三种不同方式输入: The instruction pulse can be input in

	PD-	5		<p>three different ways:</p> <p>1: 指令方向和脉冲输入 Command direction and pulse input</p> <p>2: 顺时针/逆时针脉冲输入 Clockwise / anticlockwise pulse input</p> <p>3: 相位差 90 度的正交脉冲输入 Quadrature pulse input with phase difference of 90 degrees</p>
	PA+ PA- PB+ PB- PZ+ PZ- OZ GND	20 19 18 17 15 16 22 1	编码器信号输出 Encoder signal output	编码器信号 (ABZ) 的输出端口。通过参数设定, AB 信号可分频输出和逻辑取反输出。The output port of the encoder signal (ABZ). Through the parameter setting, the AB signal can be divided into frequency division output and logic fetch reverse output.
	Vref AGND	25 13	模拟量输入 Analog input	模拟电压输入端口。速度或力矩控制时, 用于接收速度或力矩指令。电压输入范围-10V~+10V。Analog voltage input port. Speed or torque control used to receive speed or torque instructions. Voltage input range -10V~+10V.

2.3.2 CN2 端口信号定义(进阶版) CN2 port signal definition (Advanced Edition)

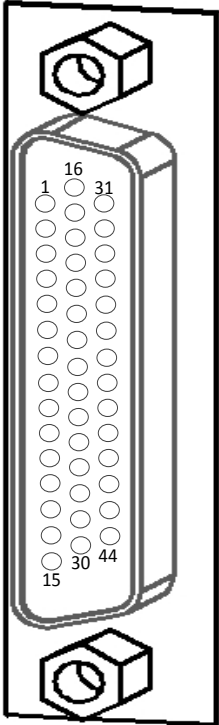
	引脚 pin	引脚号 Pin number	名称 Name	功能 Function
	DC12~24V COM	38 40	+12~+24V 控制电源、 地 +12~+24V control power, ground	输入输出控制信号的输入电源和地 The input and output control signals are input power and ground
	SigIn1 SigIn2 SigIn3 SigIn4 SigIn5 SigIn6 SigIn7 SigIn8 SigIn9 SigIn10	6 22 7 23 8 24 9 39 25 26	可编程输入 端 口 信 号 Programm able input port signal	输入指令信号。出厂时各个输入信号端口指 定默认功能: Input instruction signal. When factory leaves, each input signal port specifies the default function: SigIn1:伺服使能 servo enable SigIn2:报警复位 alarm reset SigIn3:位置偏差清除 position bias removal SigIn4: 脉 冲 输 入 禁 止 pulse input is prohibited SigIn5:正转驱动禁止 positive drive ban SigIn6: 反 转 驱 动 禁 止 reverse drive prohibited SigIn7:内部速度指令选择 1 internal speed command select 1 SigIn8:内部速度指令选择 2 internal speed command select 2 SigIn9:内部速度指令选择 3 internal speed command select 3 SigIn10:无功能指定: no function specified:
	SigOut1 SigOut2 SigOut3	10 11 12	可编程输出 端 口 信 号 Programm	输出指令信号。出厂时各个输出信号端口指 定的功能: Output instruction signal. The function specified by each output signal

	SigOut4	27	able output	port at the factory:
	SigOut5	13	port signal	SigOut1: 伺服准备好 servo ready SigOut2: 报警检出 alarm detected SigOut3: 定位完成 location completed SigOut4: 紧急停止检出 emergency stop detection SigOut5: 电磁制动 electromagnetic brake
	PP+24V	35	指令脉冲输入端口	PP+24V、PD+24V:24V 信号输入 Signal input
	PP+	4	Command	PP+、PD+:5V 信号输入 Signal input
	PP-	20	pulse input	指令脉冲有三种不同方式输入: There are three different ways to input an instruction pulse:
	PD+24V	36	port	1: 指令方向和脉冲输入 instruction direction and pulse input
	PD+	21		2: 顺时针/逆时针脉冲输入 clockwise / counterclockwise pulse input
	PD-	5		3: 相位差 90 度的正交脉冲输入 quadrature pulse input with phase difference of 90 degrees
	PA+	17	编码器差分输出与集电极开漏输出	编码器信号 (ABZ) 的输出端口。通过参数设定, AB 信号可分频输出和逻辑取反输出。
	PA-	31	信 Encoder	PA+与 PA、PB+与 PB、PZ+与 PZ-为差分对结构 The output port of the encoder signal (ABZ). Through the parameter setting, the AB signal can be divided into frequency division output and logic fetch reverse output.
	PB+	33	differential	PA+ and PA, PB+ and PB, PZ+ and PZ- are differential pairs
	PB-	18	output with	OA、OB、OZ、为集电极开漏结构 OA, OB, OZ, the open drain structure for the collector
	PZ+	16	collector	
	PZ-	1	open drain	
	OA	19	output	
	OB	34	letter	
	OZ	2		
	GND	32		
	Vref	43	模拟量输入	模拟电压输入端口。速度或力矩控制时, 用

	AGND	44	Analog input	于接收速度或力矩指令。电压输入范围 -10V~+10V。Analog voltage input port. Speed or torque control used to receive speed or torque instructions. Voltage input range -10V~+10V.
--	------	----	--------------	---

2.2.3 CN2 端口类型 CN2 port type

1. 数字输入接口 Digital input interface

数字输入接口电路可由开关、继电器、集电极开路三极管、光电耦合器等进行控制。继电器需选择低电流继电器，以避免接触不良的现象。外部电压范围 DC12V~24V。The digital input interface circuit can be controlled by switch, relay, collector, open circuit triode, photoelectric coupler, etc.. The relay needs to select low current relay to avoid the bad contact. External voltage range DC12V to 24V.

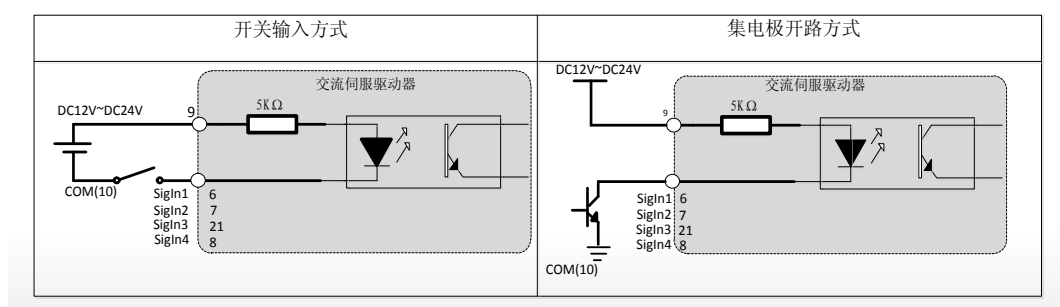

2. 数字输出接口 Digital output interface

输出电路采用达林顿光电耦合器，可与继电器、光电耦合器连接。The output circuit adopts Darlington photoelectric coupler, and can be connected with relay and photoelectric coupler.

注意事项：Matters needing attention:

● 外部电源由用户提供，但是必须注意，如果电源的极性接反，可能导致伺服驱动器损坏。The external power supply is provided by the user, but it must be noted that if the polarity of the power is reversed, the servo drive may be damaged.

●输出为集电极开路形式，最大电流 70mA，外部电源最大电压 25V。如果超过限定要求或输出直接与电源连接，可能导致伺服驱动器损坏。The output is in the form of an open collector, the maximum current is 70mA, and the maximum voltage of the external power supply is 25V. If the limit request or output is connected directly to the power source, the servo drive may be damaged.

●如果负载是继电器等感性负载，必须在负载两端反并联续流二极管。如果续流二极管接反，可能导致伺服驱动器损坏。If the load is an inductive load such as a relay, the freewheeling diode must be connected in parallel at both ends of the load. If the freewheeling diode is turned on, the servo drive may be damaged.

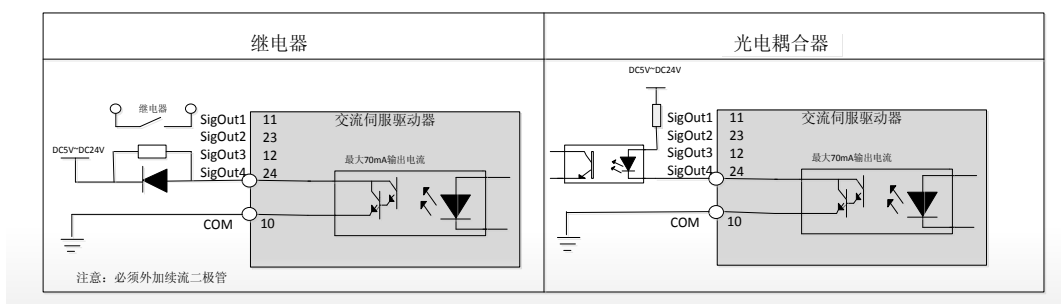

3.位置脉冲指令接口 Position pulse instruction interface

有差分驱动和单端驱动两种接法，推荐差分驱动接法。接线宜采用双绞线。There are two ways to drive differential drive and one end drive. Differential drive connection is recommended.

Twisted pair should be used for wiring.

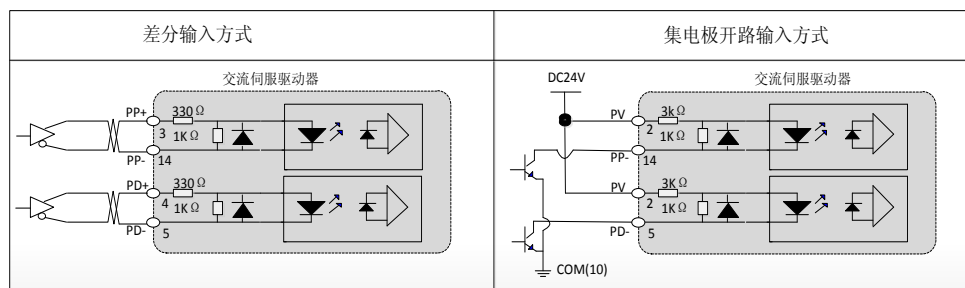

●在差分输入方式下，建议采用 AM26LS31 类似线驱动芯片；为了使传送的脉冲数据有很好的抗干扰能力，建议采用差分驱动方式；最大输入脉冲频率 550kHz(kpps)。In the differential input mode, the proposed use of AM26LS31 similar line driving chip; in order to make the pulse data transmission have very good anti-interference ability, recommend the use of differential drive mode; the maximum input pulse frequency 550kHz (kpps).

●在采用集电极开路输入方式下,最大输入脉冲频率 200kHz(kpps) 。 Under the open collector input mode, the maximum input pulse frequency is 200kHz (kpps).

4. 编码器信号差分驱动输出 Encoder signal differential drive output

将编码器信号分频后通过线驱动器(26LS31)输出到上位控制器。 After the encoder signal is divided into frequency, it is output to the upper controller through line driver (26LS31).

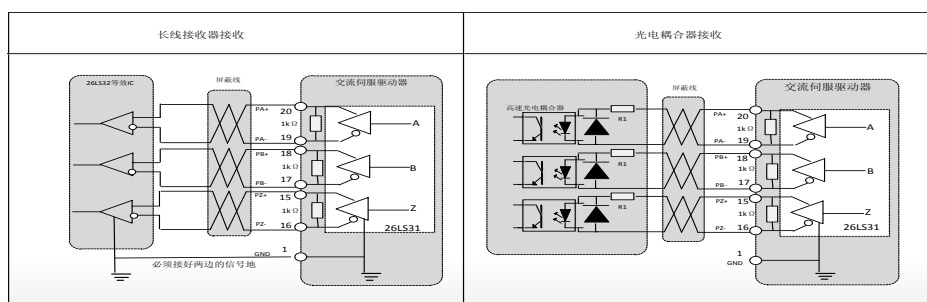

●在长线接收器接收时,驱动器编码器信号地(GND)必须和上位控制器信号地连接。 When the long line receiver is received, the driver encoder signal (GND) must be connected to the upper controller signal.

●在光电耦合器接收时,上位控制器使用高速光电耦合器(例如6N137),限流电阻R1的值220 Ω 左右。 When the optocoupler is received, the upper controller uses a high-speed optocoupler (for example, 6N137), and the current limiting resistor R1 has a value of about 220.

5. 编码器 ABZ 信号集电极开路输出 Encoder ABZ signal open collector output

伺服驱动器以集电极开路方式输出编码器的 ABZ 信号。由于 Z 信号脉宽较窄,上位机请使用高速光电耦合器接收。 The servo drives the ABZ signal of the encoder in an open collector mode. Since the Z pulse width is narrow, the upper computer should be received by high-speed optocoupler.

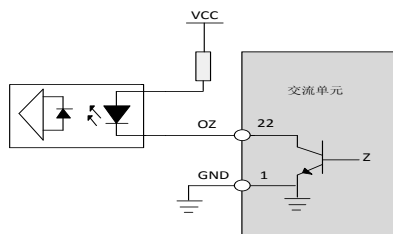

- VCC 最大电压 30V，输出电流最大 50mA。VCC maximum voltage 30V, output current maximum 50mA.

- 仅进阶版伺服单元支持 A、B 信号的集电极开路输出功能。Only the advanced servo unit supports the open collector output function of the A and B signals.

2.4 CN3 编码器接口 CN3 encoder interface

2.4.1 CN3 编码器信号定义(标准版) CN3 encoder signal definition (Standard Edition)

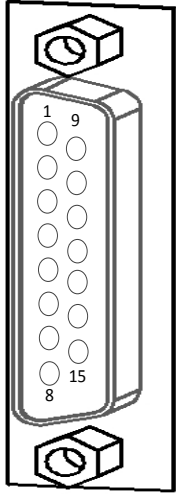
	编码器类型 Encoder	引脚号 Pin number	名称 Name		
	增量式 Incremental encoder	8	+5v	15	GND
	3	A+	11	A-	
	10	B+	2	B-	
	1	Z+	9	Z-	
	6	U+	7	U-	
	5	V+	13	V-	
	12	W+	4	W-	
	14	PE	绝对式 Absolute encoder	4	SD+
	3	SD-		14	FG
	15	GND			

2.4.2 CN3 编码器信号定义(进阶版) CN3 encoder signal definition (Advanced Edition)

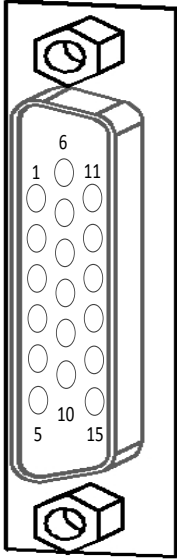
	编码器类型 Encoder	引脚号 Pin	名称 Name
	增量式 Incremental encoder	1	A+
2		A-	
3		W+	
4		V-	
5		U+	
6		Z+	
7		B-	
8		W-	
9		U-	
10		+5V	
11		Z-	
12		B+	
13		V+	
14		FG	
15		GND	
绝对式 Absolute encoder	6	SD+	
	11	SD-	
	14	FG	
	15	GND	

2.3 标准接线 Standard connection

2.3.1 位置控制接线图(标准版) Position control wiring diagram (Standard Version)

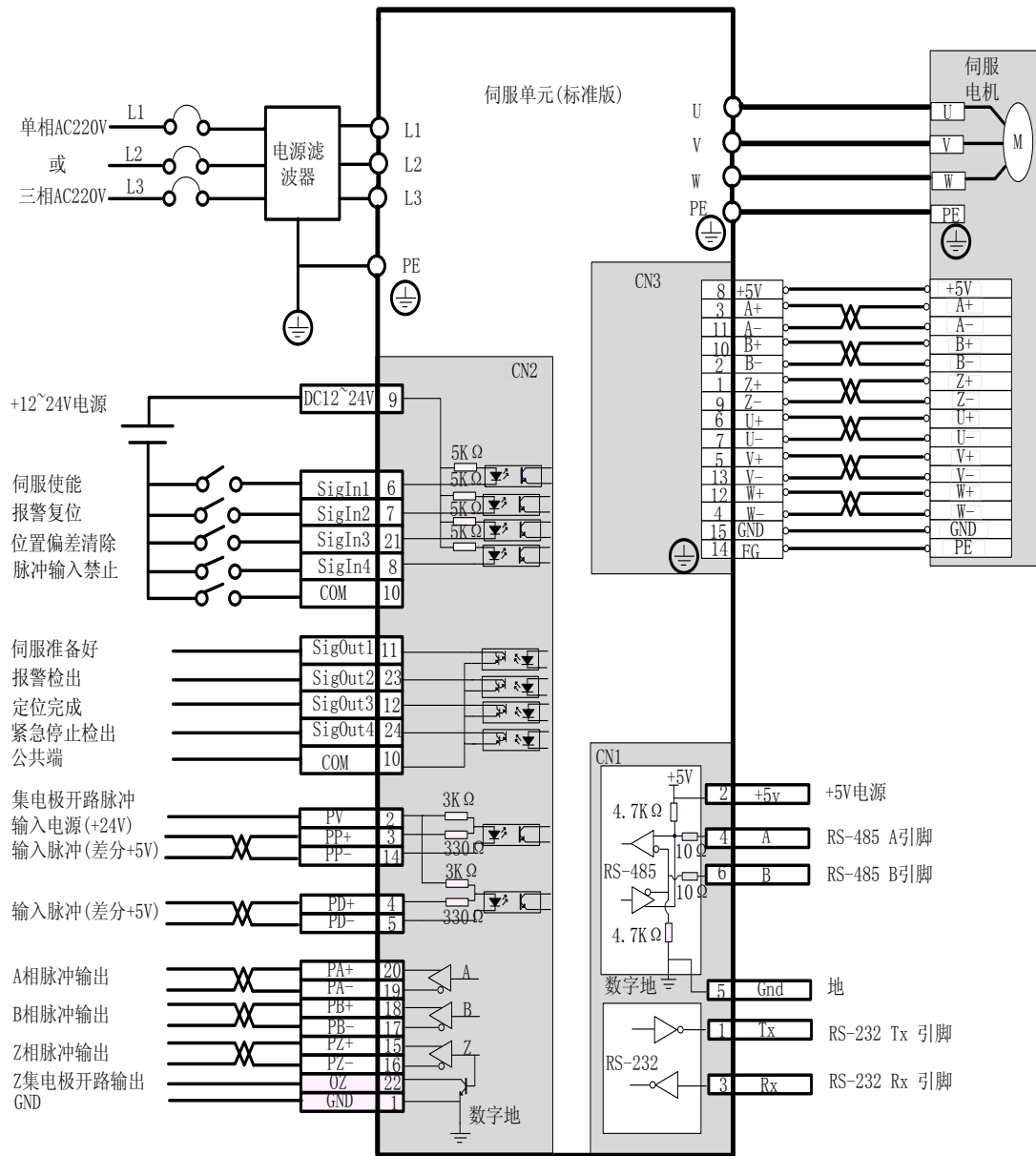

2.3.2 位置控制接线图(进阶版) Position control wiring diagram (Advanced Edition)

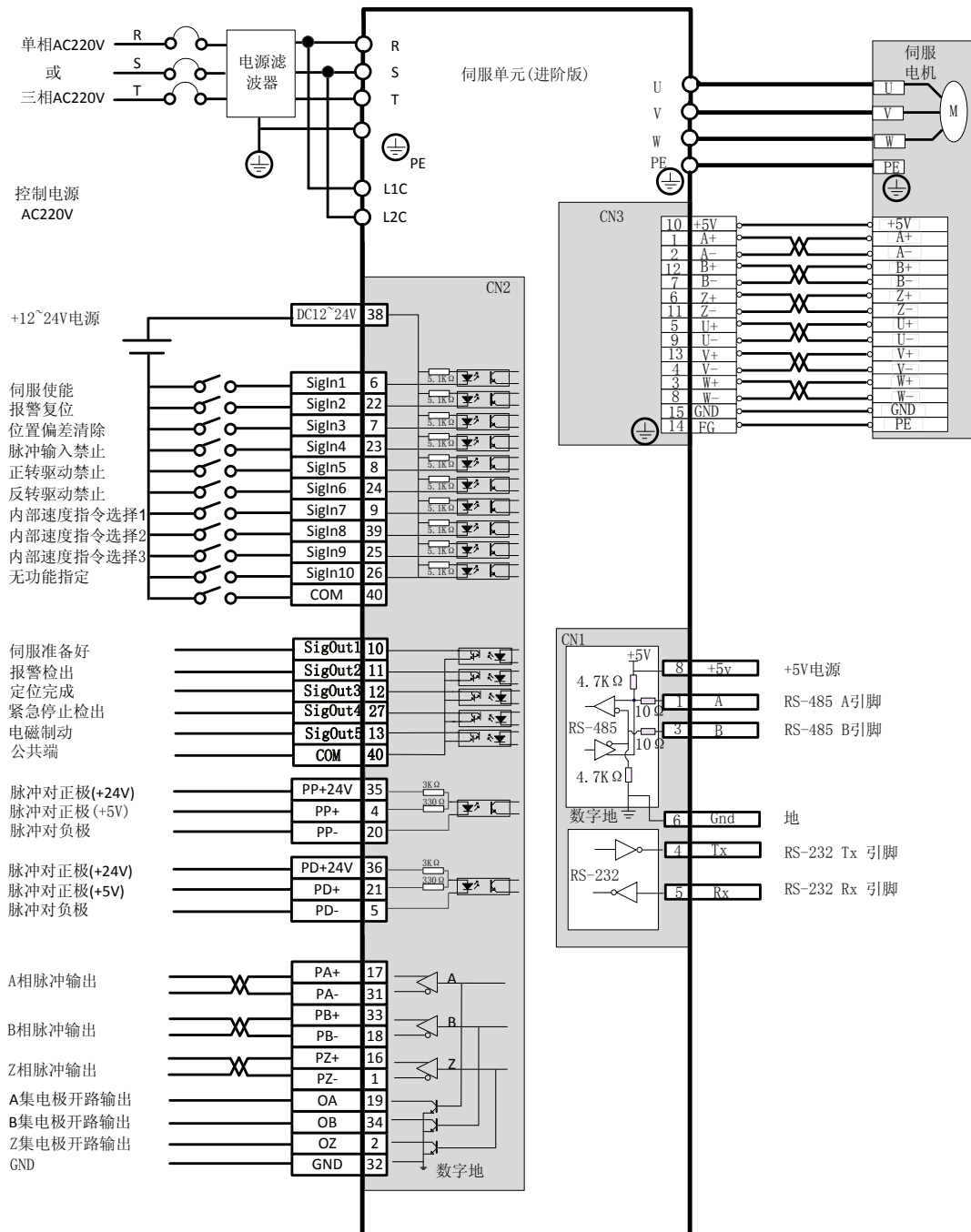

2

2.3.3 速度/转矩控制接线图(标准版) Speed / torque control wiring diagram (Standard Version)

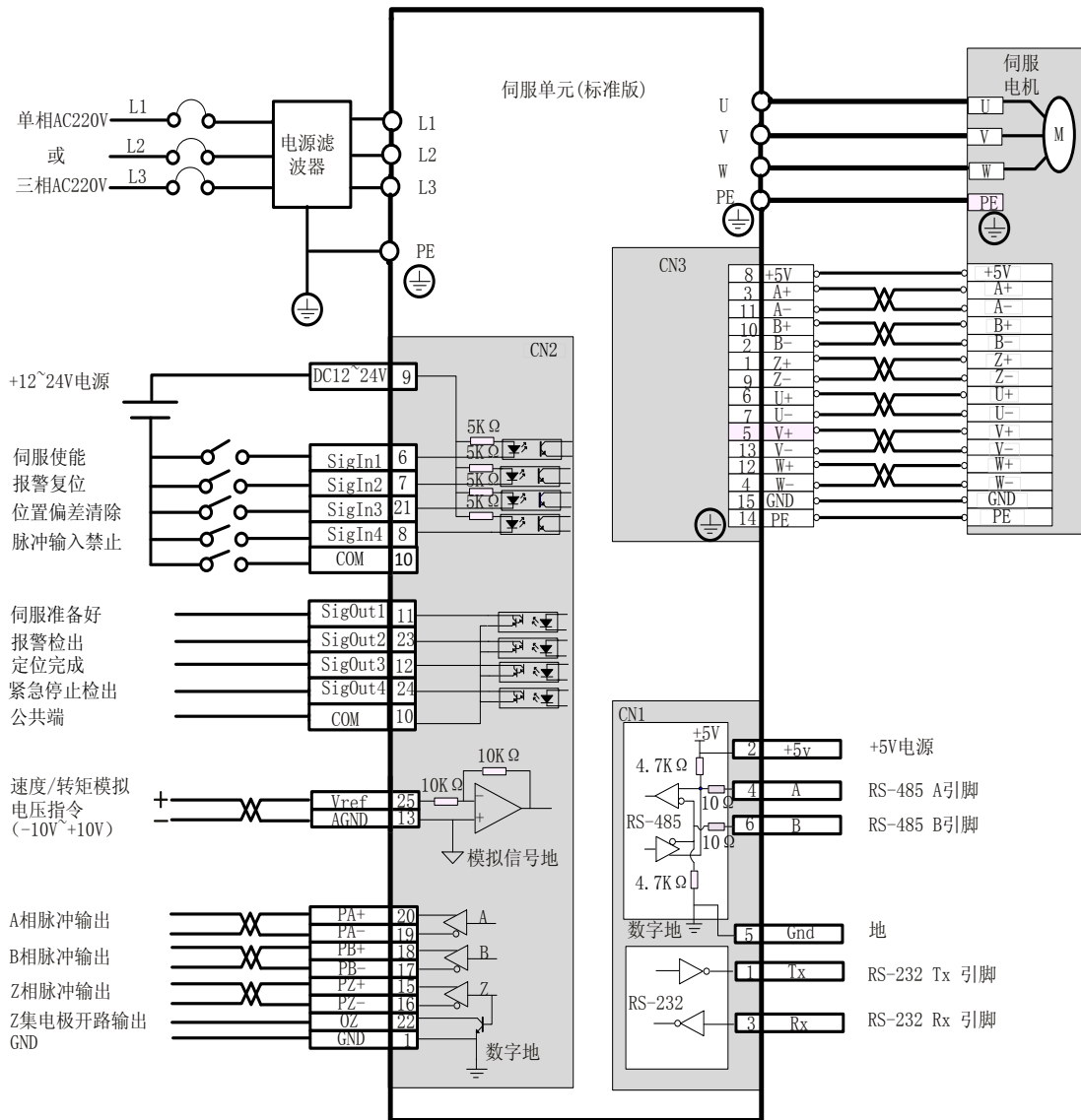

2.3.4 速度/转矩控制接线图(进阶版) Speed / torque control wiring diagram (Advanced Edition)

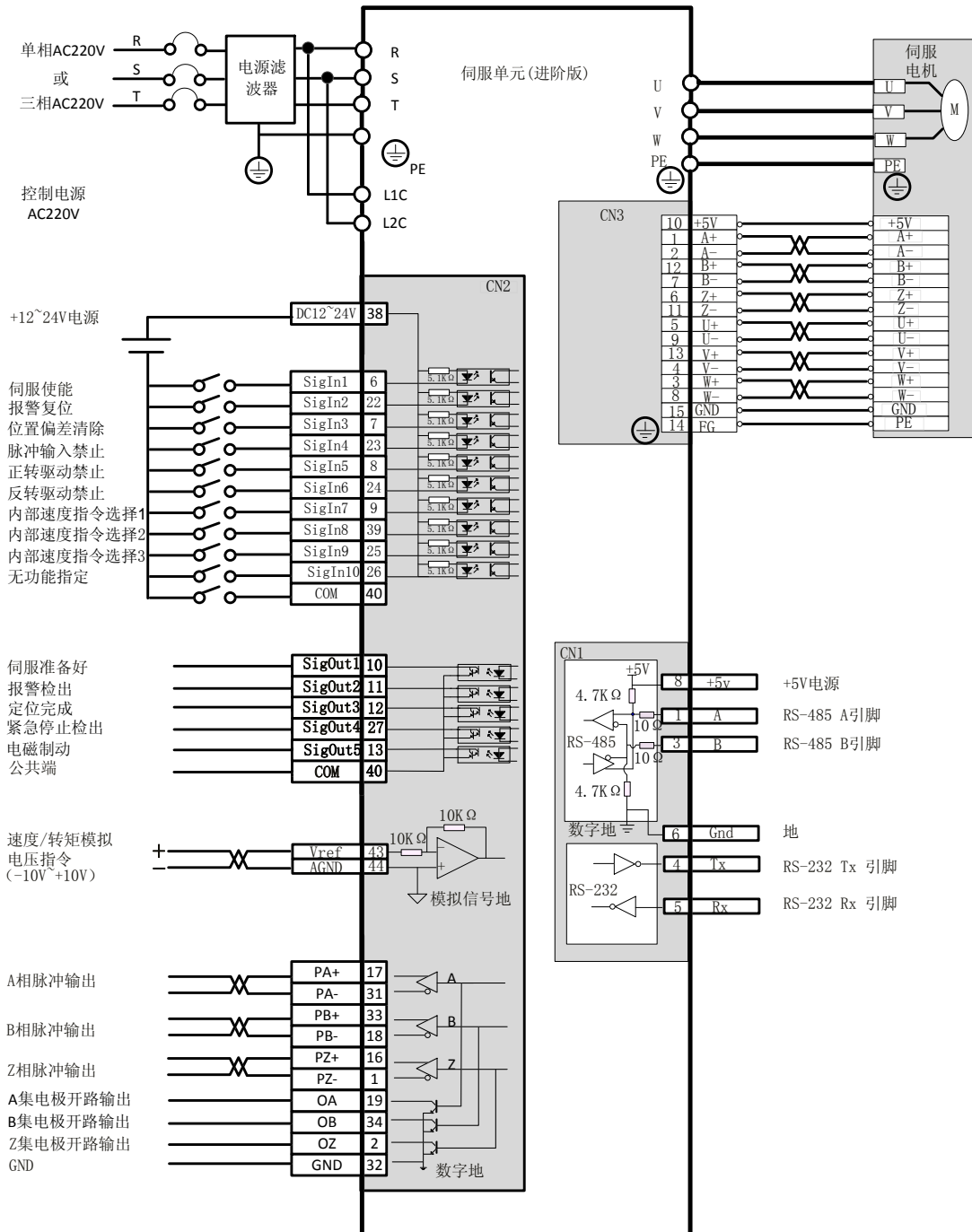

第 3 章显示与操作 The third chapter shows and operates

3.1 面板组成 Panel composition

3.1.1 显示屏与按键(标准版) Display and button (Standard Edition)

3

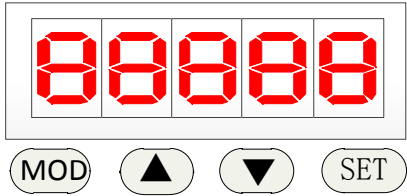

按键 Key	按键名称 Key name	功能 Function
MODE	模式选择键 Mode select key	1 模式切换 Mode switching 2 返回上级目录 Return to higher directory
▲	数字增加键 Digital add key	增加数字，长按具有重复效果 Add numbers, Long press with repeat effect
▼	数字减小键 Digital reduction key	减小数字，长按具有重复效果 Digital reduction, Long press with repeat effect
SET	移位确定键 Shift key	1 数字移位 Digital shift 2 确定设定（需长按 1 秒钟）Set the setting (press for 1 seconds) 3 结束参数设定（需长按 1 秒钟）End the parameter setting (press for 1 seconds l)

3.1.2 显示屏与按键(进阶版) Display and button (Advanced Edition)



按键 Key	按键名称 Key name	功能 Function
MODE	模式选择键 Mode select key	1 模式切换 Mode switching 2 返回上级目录 Return to higher directory
▲	数字增加键 Digital add key	增加数字，长按具有重复效果 Add numbers, Long press with repeat effect
▼	数字减小键 Digital reduction key	减小数字，长按具有重复效果 Digital reduction, Long press with repeat effect
Shift	移位键 Shift key	光标移位 Cursor shift
SET	确定键 Definite key	1 确定设定 Determine settings 2 结束参数设定 End parameter setting

注意：若显示屏 5 位小数点全部在闪烁，警示有报警产生。必须清除报警后，驱动器才能正常工作。**Note: if the 5 decimal points of the display screen are all flashing, the alarm will be generated by the alarm. After the alarm has to be cleared, the drive will work properly.**

3.2 模式切换 Mode switching

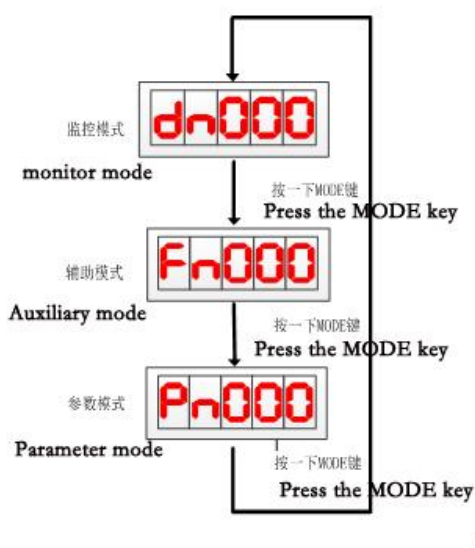

说明：当显示屏显示 Fnxxx,Dnxxx,Pnxxx 时,此时处于顶层目录，mode 键为模式切换功能，可直接向其它模式切换, 否则 mode 键为返回上层目录功能。Description: when the screen shows Fnxxx, Dnxxx, Pnxxx, at this time in the top directory, mode key for mode switching function, can be switched directly to other mode, otherwise, mode key to return to the upper directory function.

3.3 监控模式(Dn)操作 Monitoring mode (Dn) operation

例：查看dn015号监控参数,此时sigOut1、sigOut5端口为低电平，sigOut2, sigOut3, sigOut4 端口为高电平。Example: check dn015 monitoring parameters, at this time, sigOut1 and sigOut5 port is low, sigOut2, sigOut3, sigOut4 port is high.

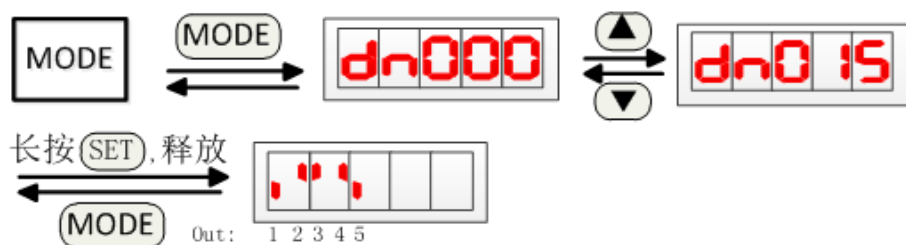

3.4 辅助模式(Fn)操作 Auxiliary mode (Fn) operation



● 辅助功能一览表 Auxiliary function list

编号 NO.	说明 Description
Fn000	报警记录查询 Alarm record query
Fn001	用户参数永久写入。若用户对 Pn000~Pn280 中的参数进行了设置，为下次上电后，驱动器载入用户修改的参数，必须执行本操作，将参数写入内部 EEPROM 芯片。执行操作后，需要 5 秒左右时间，将所有参数写入 EEPROM 中。User parameters are permanently written. If the user sets the parameters in the Pn000~Pn280, the driver must load the user's modified parameters for the next time they are powered on. The parameter is written to the internal EEPROM chip. After performing the operation, it takes about 5 seconds to write all the parameters into the EEPROM.
Fn002	JOG 试运行操作 JOG commissioning operation
Fn003	对当前检出的报警进行清除 Clear the currently detected alarms
Fn004	将参数表中的 Pn000~Pn280 的参数，根据 Pn000 的设置情况，恢复为出厂默认值。Returns the default factory value of the Pn000~Pn280 parameter in the parameter list, based on the Pn000 settings.
Fn005	位置偏差清零 Clear position deviation
Fn006	SigOut 端口强制输出，强制状态仅限于此操作下有效。The SigOut port forces output, and the force state is valid only for this operation. 0: SigOut 所有端口取消强制状态。SigOut all ports cancel mandatory status. 1: SigOut 所有端口强制输出高电平。SigOut all ports forced output high level. 2: SigOut 所有端口强制输出低电平。SigOut all ports forced output low.
Fn007	模拟转矩指令电压校正 Analog torque command voltage correction

Fn008	模拟速度指令电压校正 Analog speed command voltage correction
Fn009	母线电压校正 busbar voltage correction
Fn010	温度校正 Temperature correction
Fn011	报警记录初始化 Alarm record initialization
Fn012	编码器调零 Encoder zeroing
Fn015	绝对式编码器多圈数据归零 Absolute encoder, multi circle data, zeroing
Fn016	绝对式编码器报警复位 Absolute encoder, alarm reset
Fn018	负载惯量推定 Load inertia estimation

3.4.1.1 Fn000 报警功能查询 Fn000 alarm function inquiry

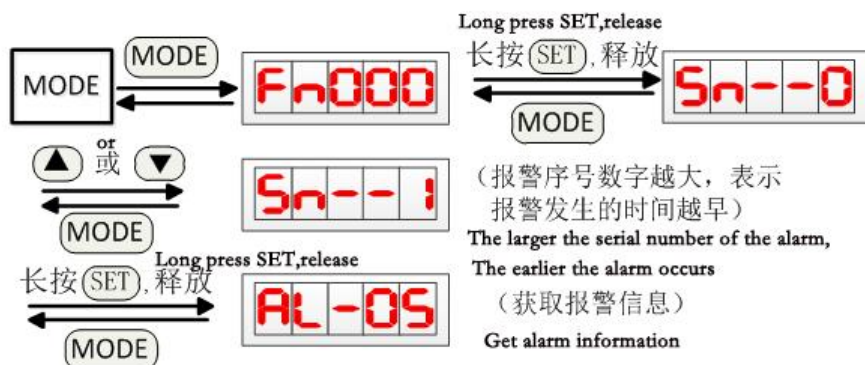

3.4.1.2 Fn001 用户参数永久写入 Fn001 user parameters are permanently written

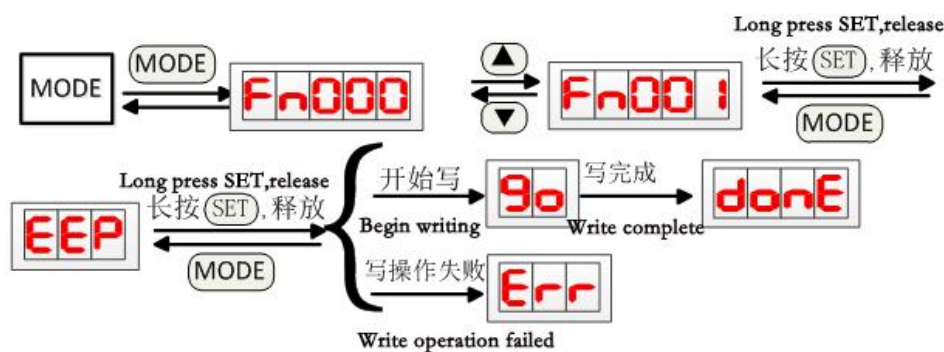

说明 1: 若最后操作显示 , 可能是驱动器内部正在执行写数据操作, 请等待几秒钟再尝试。

Note 1: if the last operation shows  that it may be a write data operation within the drive, please wait a few seconds to try again.

说明 2: 必须等待写完成再断电, 否则重新开机后, 可能导致存储芯片内容破坏 (AL-01 报警)。

Note 2: you must wait for writing to complete the power failure, otherwise, after rebooting, may cause storage chip content damage (AL-01 alarm).

3.4.1.3Fn002 试运行操作 Fn002 commissioning operation

0: 点动模式 Inching mode

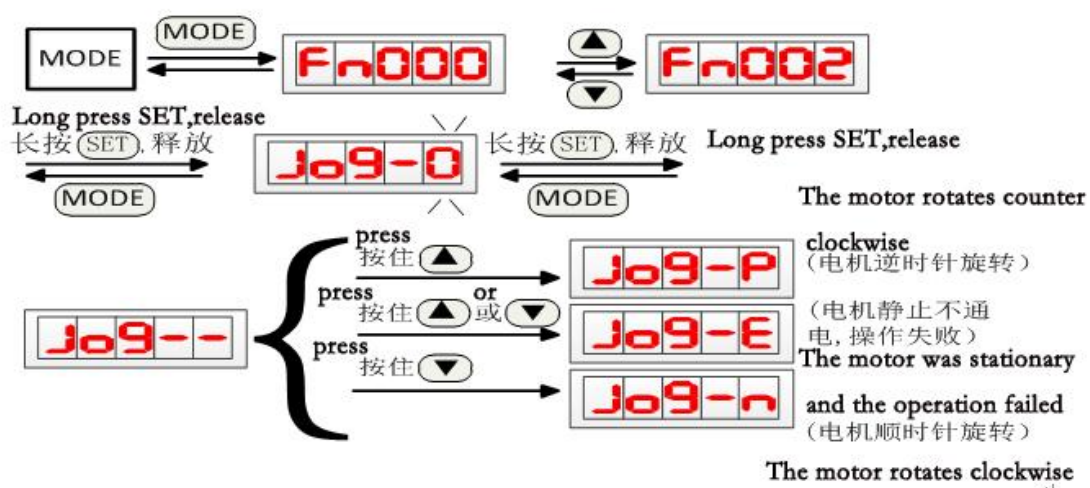

Jog 运行速度与加减速时间可由以下参数设定: Jog running speed and acceleration and deceleration time can be set by the following parameters:

Pn177	JOG 速度 speed	0~5000	200	r/min
Pn178	JOG 加速时间 Acceleration time	5~ 10000	100	ms
Pn179	JOG 减速时间 Deceleration time	5~ 10000	100	ms

1: 进入调速模式 Speed regulation mode

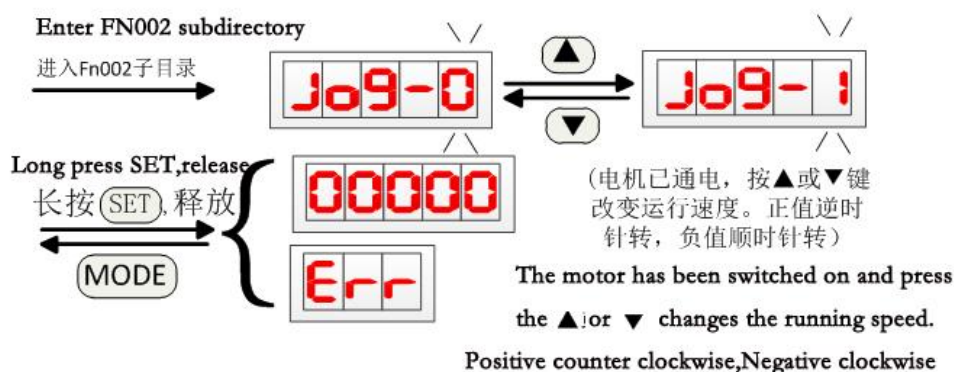

2:退出调速模式 Exit speed regulation mode

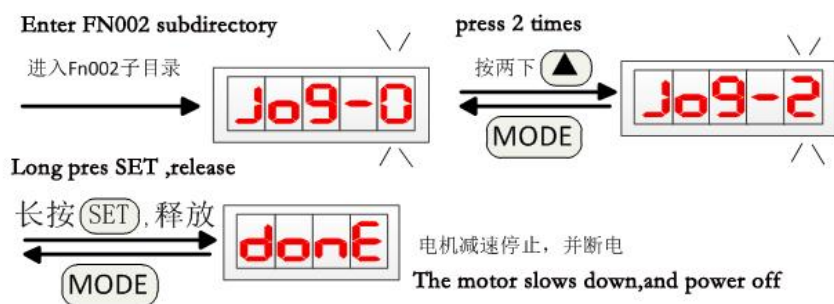

运行模式 Operation mode	说明 Description
0	点动模式。按住▲或▼键, 电机将进行顺时针或逆时针旋转; 释放▲或▼键, 电机将停止旋转, 处于不通电状态。Inching model. Press ▲ or ▼key motor will rotate clockwise or counterclockwise; release ▲ or ▼key, the motor will stop rotating in the energized state.
1	进入调速模式, 电机通电工作。驱动器处于速度环模式, 运行速度由按键▲或▼输入。在电机运行过程中, 可进行其它的菜单操作。若使电机停止旋转, 请进入 Jog_2 模式。Enter the speed control mode, the motor power work. Driver in speed loop mode, running speed by the key input ▲ or ▼. During the operation of the motor, other menu operations can be carried out. If the motor is stopped rotating, enter the Jog_2 mode.
2	退出调速模式, 电机断电。Exit the speed regulation mode and the motor is out of power.

说明：若操作显示 **JOG-E** 或 **Err**，其可能的原因有：Explanation: if the operation is displayed

JOG-E or **Err** possible reasons for:

1: 电机已处于使能或旋转状态。在 JOG 试运行操作前，电机须处于非工作状态。建议试运行前，伺服驱动器控制接口不接任何控制线。1: the motor is in the enabling or rotating state. The motor must be in a non working state prior to the JOG commissioning operation. During commissioning, the servo driver control interface does not receive any control lines.

2: 伺服驱动器发生过报警，且报警未清除。2: servo drive alarm occurred, and the alarm is not cleared.

3.4.1.4 Fn003 报警清除操作 Fn003 alarm cleanup operation

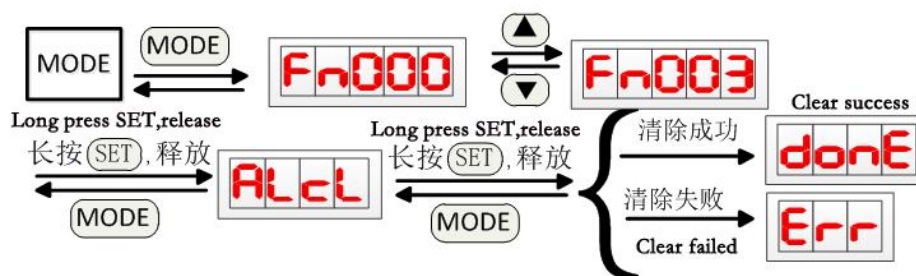

说明：

当最后清除失败，显示 **Err**，则检出的报警只有再上电后才可清除。Explanation: when the final cleanup

fails, shows **Err**, the detected alarm is cleared only after power on.

通过清除操作可清除的报警 An alarm that can be cleared by clearing operations		再上电才可清除的报警 The alarm can be cleared before power on	
AL--02	低电压 low voltage	AL--01	存储器异常 Memory exception
AL--05	过载 1 Overload 1	AL--03	过电压 Overvoltage
AL--07	电机转速过高 Motor speed is too high	AL--04	智能功率模块异常 Intelligent power module exception
AL--08	散热片过热 Radiator overheating	AL--06	过载 2 Overload 2
AL--10	脉冲频率过高 Too high pulse frequency	AL--09	编码器异常 Encoder exception
AL--11	位置脉冲偏差量过大 The position	AL--13	CPU 内部故障 CPU internal fault

	pulse deviation is too large		
AL--12	电流采样回路可能损坏 The current sampling loop may be damaged	AL--17	编码器信号分频输出设置异常 Encoder signal frequency division output abnormal setting
AL--14	紧急停机 Emergency shutdown	AL--18	电机代码设置不当 Improper motor code setting
AL--15	驱动禁止异常 Drive forbidden exception	AL--20	功能端口重复设置 Function port repeat settings
AL--16	制动平均功率过载 Brake mean power overload	AL--21	存储器内容完全破坏 Memory contents are completely destroyed
AL--19	功率模块过热 Power module overheating	AL--22	看门狗定时器溢出 Watchdog timer overflow
		AL--31~ AL--43	绝对式编码器相关报警 Absolute encoder related alarm

3.4.1.5 Fn004 参数初始化操作 Fn004 parameter initialization operation

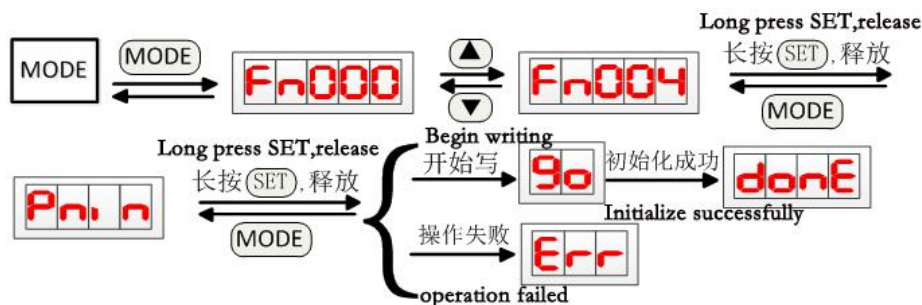

说明 1: 若最后操作显示 **Err**, 其可能的原因: Note 1: if the last operation is displayed **Err**, the possible cause of it is shown:

- 1: 驱动器正在执行写操作。 1: the driver is performing write operations.
- 2: 参数 Pn000 没有开放参数初始化功能。 2: parameter Pn000 has no open parameter initialization function.

说明 2: 必须等待写完成再断电, 否则重新开机后, 可能导致存储芯片内容破坏 (AL-01 报警)。

Note 2: you must wait for writing to complete the power failure, otherwise, after rebooting, may cause storage chip content damage (AL-01 alarm).

3.4.1.6 Fn005 位置偏差清零操作 Fn005 position offset reset operation

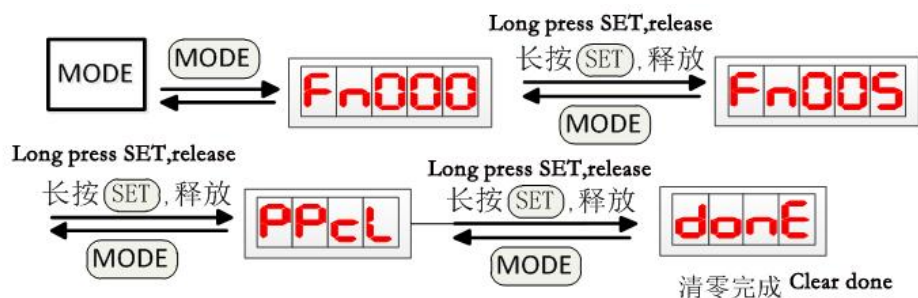

3.4.1.7 Fn006 端口强制输出 Fn006 port forced output

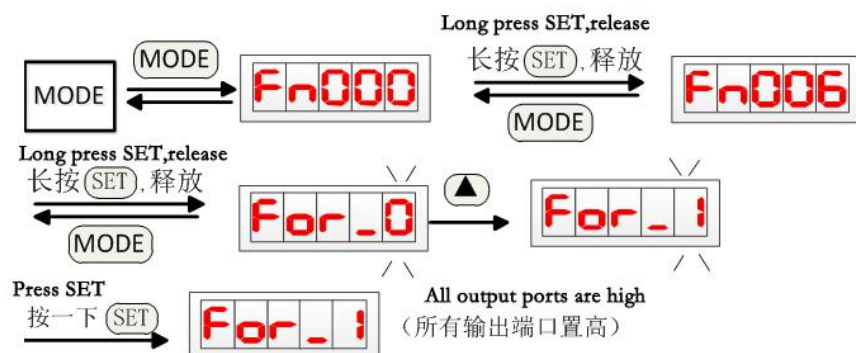

参数选择 Parameter selection	说明 Description
0	取消强制状态 Cancel mandatory status
1	所有 SigOut 端口强制置高 All SigOut ports are forced high
2	所有 SigOut 端口强制置低 All SigOut ports are forced low

3.4.1.8 Fn007 模拟转矩指令电压校正 Fn007 analog torque command voltage correction

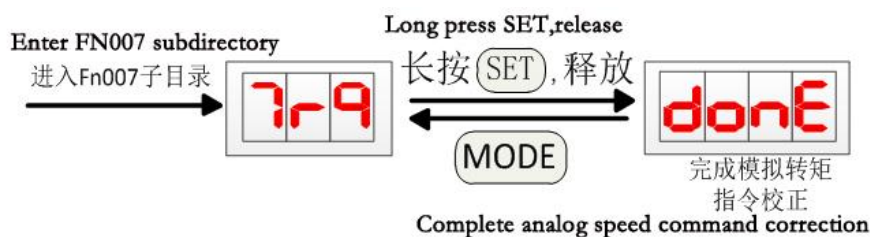

注 1: 在进行校正操作前, 先将 CN2 的模拟电压输入端口 Vref (25 脚) 接入参考零电压。

Note 1: before the calibration operation, the analog voltage input port Vref (25 pin) of the CN2 is connected to the reference zero voltage.

3.4.1.9 Fn008 模拟速指令电压校正 Fn008 analog speed command voltage correction

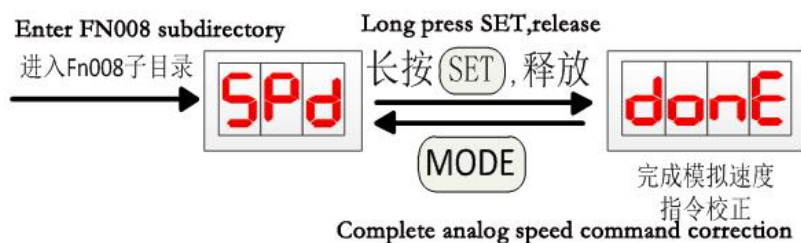

注 1: 在进行校正操作前, 先将 CN2 的模拟电压输入端口 Vref (25 脚) 接入参考零电压。

Note 1: before the calibration operation, the analog voltage input port Vref (25 pin) of the CN2 is connected to the reference zero voltage.

3.4.1.10 Fn009 母线电压校正 Fn009 bus voltage correction

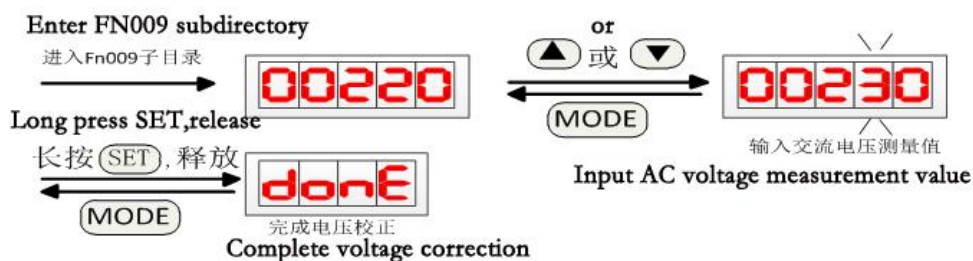

注 1: 在进行校正时, 必须接入控制电源和动力电源, 并测量驱动器输入的交流电压, 输入至本操作中。Note 1: when correcting, the control power supply and the power supply must be connected and the AC voltage inputted by the driver is measured and input into the operation.

3.4.1.11 Fn010 温度校正 Fn010 temperature correction

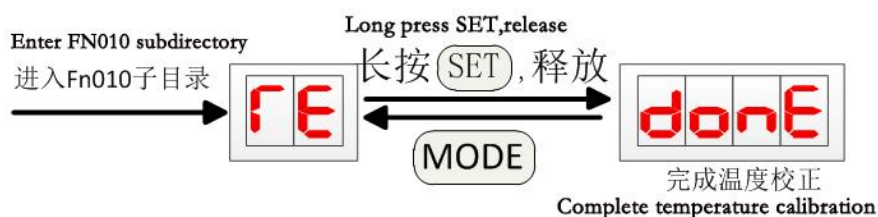

3.4.1.12 Fn011 报警记录初始化操作 Fn011 alarm record initialization operation

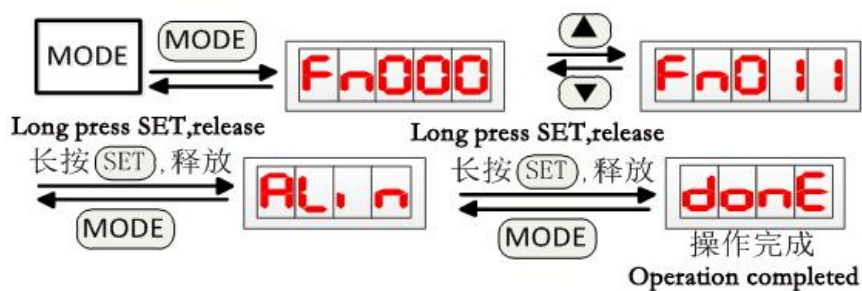

3.4.1.13 Fn012 编码器调零 Fn012 encoder zeroing

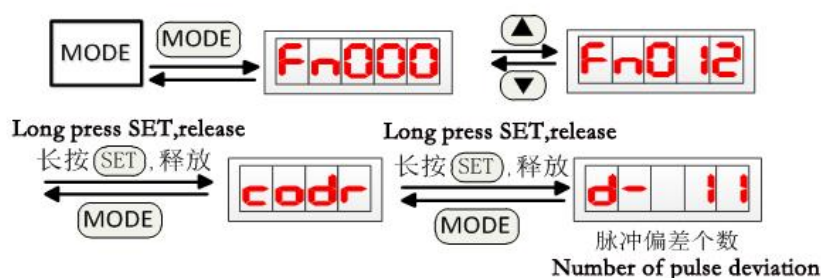

调零操作前, 确认电机代码 Pn001 设置值与实际电机型号一致, 否则可能导致电机电流过大, 损坏电机。调零时, 不需要内部使能或外部使能电机, 电机将正转几圈, 然后锁定零位。当显示的脉冲偏差个数小于

10 时, 可视为电机已对准零位。Before setting the zero operation, confirm the motor code Pn001 setting value is consistent with the actual motor model, otherwise it may cause the motor current is too large, damage the motor. Zero time, no internal enable or external enable motor, the motor will be several laps, and then lock the zero position. When the number of pulses displayed is less than 10, the motor is aligned to zero.

注 1: 若电机发热严重, 须冷却一段时间。Note 1: if the motor is very hot, it must cool down for a period of time.

注 2: 绝对器编码器调零完成后, 须等待几秒钟完成数据写入, 才能断电。Note 2: absolute encoder, after the zero adjustment is completed, have to wait a few seconds to complete the data written to power off.

3.4.1.14 Fn015 绝对式编码器多圈数据归零 Fn015 absolute encoder multi turn data zeroing

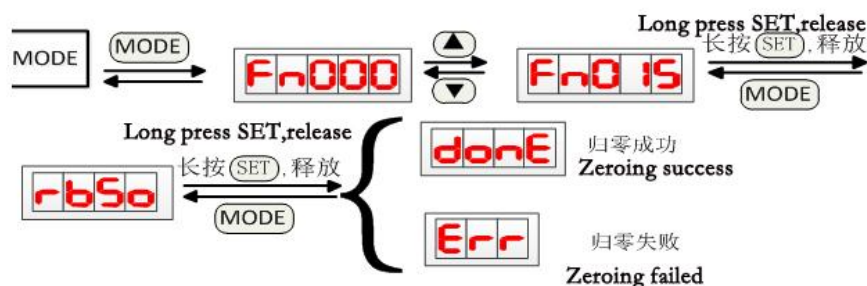

若归零成功, 多圈数据将置 0, 同时所有锁存的编码器报警被复位; 反之, 可能由于编码器出现通信故障报警或电机处于使能状态, 导致不能进行多圈数据归零操作。If zero success, multi ring data will be set to 0, while all the latch encoder alarm is reset; on the other hand, may be due to the encoder communication fault alarm or the motor is enabled to multi circle data zero operation.

3.4.1.15 Fn016 绝对式编码器报警复位 Fn016 absolute encoder alarm reset

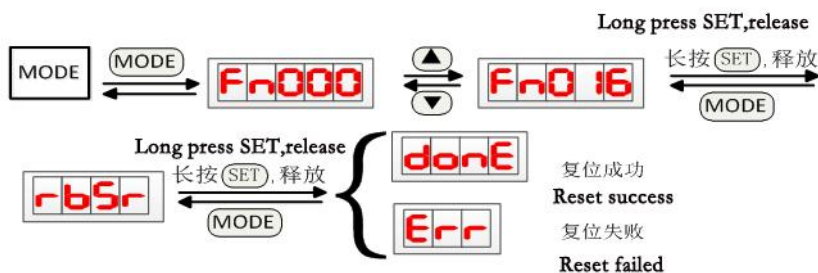

若编码器报警复位成功, 所有锁存的编码器报警被复位; 反之, 可能由于编码器出现通信故障报警或电机处于使能状态, 导致不能进行复位操作。If the encoder alarm reset is successful, all latch encoder alarms

are reset; otherwise, there may be a communications malfunction alarm or a motor in the enable state, resulting in no reset operation.

3.4.1.16 Fn018 负载惯量推定 Fn018 load inertia estimation



3

3.5 用户参数模式(Pn)操作 User parameter mode (Pn) operation



● 选择参数编号 Select parameter number

例：选择 Pn011 参数。Example: select the Pn011 parameter.

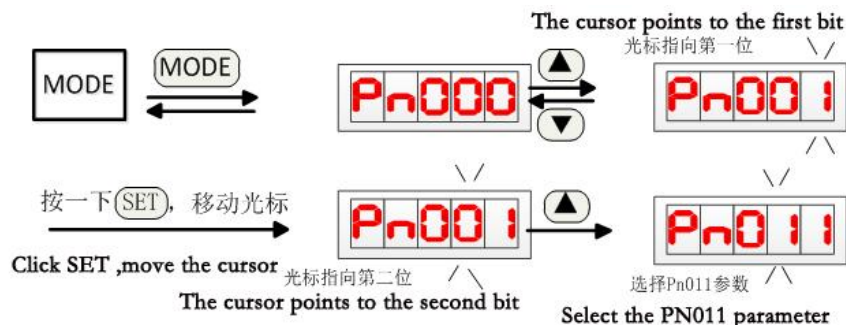

● 参数编辑 Parameter editing

例：把 Pn178 参数的当前值由 100 改成 200,具体操作如下： Example: the current value of the Pn178 parameter is changed from 100 to 200, and the following is the specific operation:

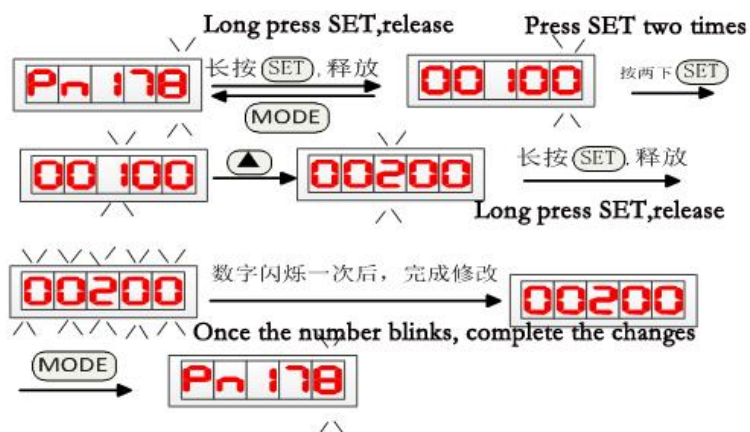

注：参数编辑完成后，请等待 5 秒钟再断电。 Note: after editing the parameter, please wait for 5 seconds to power off.

第 4 章 Pn 功能参数 The fourth chapter, Pn function parameter

4.1 参数设置面板操作 Parameter settings panel action

详见第三章的“[用户参数模式操作](#)”。See the “user parameter mode operation” in chapter third

4.2 参数一览表 Parameter list

- 编号一栏中，若有符号▲，表示参数设置后，须重新上电，才能生效；若有符号◆，表示参数设置后，重新使能电机，参数才能生效；若没有特殊符号，表示立即生效。The number of column, if there is a symbol ▲, parameter setting, to be re energized to take effect; if there is a sign ◆ that said, parameter setting, re enable the motor parameters to take effect; if there is no special symbols, immediately effect.
- 适用模式一栏中，All 表示适用于转矩、速度、位置控制，T 表示适用于转矩控制，S 表示适用于速度控制，P 表示适用于位置控制。In the model column, "All" is indicated for torque, speed, position control, T, for torque control, S for speed control, and P for position control.
- 必须谨慎设置参数。若设置不当，可能会导致电机运转不稳定。Parameters must be carefully set. Improper setting may cause motor to run unstable.

4.2.1 系统控制参数 System control parameter

编号 NO.	名称 Name	取值范围 Range of values	默认 值 Defau lt value	单位 Unit	适用 apply
Pn000	参数编辑与初始化 Parameter editing and initialization	0~3	1	-	All
Pn001▲	电机代码 Motor code	0~70	7	-	All
Pn002▲	控制模式 control mode	0~5	2	-	All
Pn003	伺服使能方式 Servo enable mode	0~1	0	-	All
Pn004	伺服断使能停机方式 Servo disconnect enable shutdown mode	0~2	0	-	All

Pn005	断使能减速时间 Breaking enable deceleration time	5~10000	100	ms	All
Pn006	使用/不使用正反驱动禁止 Use / do not use positive and negative drive prohibited	0~3	0	-	All
Pn007	正/反驱动禁止停机减速时间 Positive / reverse drive, no stopping, deceleration time	0~10000	60	ms	All
Pn008	内部正转转矩限制 (CCW) Internal forward torque limit (CCW)	0~300	300	%	All
Pn009	内部反转转矩限制 (CW) Internal reverse torque limit (CW)	-300~0	-300	%	All
Pn010	外部正转转矩限制 (CCW) External forward torque limit (CCW)	0~300	300	%	All
Pn011	外部反转转矩限制 (CW) External reverse torque limit (CW)	-300~0	-300	%	All
Pn012	正转 (CCW) 转矩过载 1 报警水平 Forward (CCW) torque overload 1 alarm level	0~300	200	%	All
Pn013	反转 (CW) 转矩过载 1 报警水平 Reverse (CW) torque overload 1 alarm level	-300~0	-200	%	All
Pn014	转矩过载 1 报警检测时间 Torque overload 1 alarm detection time	1~900	250	100ms	All
Pn015	过载 2 检测时间 Overload 2 detection time	1~300	80	100ms	All
Pn016▲	增量式编码器分频输出之分子 DA Molecular DA for frequency division output of an incremental encoder	1~127	1	-	All
Pn017▲	增量式编码器分频输出之分母 DB The denominator of frequency division output of incremental encoder DB	1~127	1	-	All
Pn018▲	编码器输出脉冲 AB 相位逻辑取反 Encoder output pulse AB phase logic	0~1	0	-	All

	inversion				
Pn019▲	额定电流设置 Rated current setting	0.0~100.0	0	Arms	All
Pn020▲	额定转速设置 Rated speed setting	0~5000	0	r/min	All
Pn021	到达预定速度 Reach a predetermined speed	0~5000	500	r/min	All
Pn022	到达预定速度迟滞比较差值 Arrive at a predetermined speed, lag, compare difference	0~5000	30	r/min	All
Pn023	到达预定速度检测方向 Arrive at a predetermined speed, direction of detection	0~2	0	-	All
Pn024	到达预定转矩 Arrival torque	0~300	100	%	All
Pn025	到达预定转矩迟滞比较差值 Lag difference between arrival torque and preset torque	0~300	5	%	All
Pn026	到达预定转矩方向 Reach the desired torque direction	0~2	0	-	All
Pn027	零速检测幅度设定 Zero speed detection amplitude setting	0~1000	10	r/min	All
Pn028	零速检测回差 Zero speed test return error	0~1000	5	r/min	All
Pn029	电机电磁制动零速检测点 Zero speed detection point of motor electromagnetic brake	0~1000	5	r/min	All
Pn030	电机静止时电磁制动器延时时间 Delay time of electromagnetic brake when the motor is stationary	0~2000	0	ms	All
Pn031	电机运转时电磁制动器等待时间 When the motor is running, the electromagnetic brake wait time	0~2000	500	ms	All
Pn032	电机运转时电磁制动器动作速度 The speed of the electromagnetic brake when the motor is running	0~3000	30	r/min	All

Pn033	原点回归触发方式 Origin regression trigger mode	0~3	0	-	All
Pn034	原点回归参考点模式 Origin regression reference point mode	0~6	0	-	All
Pn035	原点回归原点模式 Origin regression origin mode	0~2	0	-	All
Pn036	原点位置偏移高位 Origin position offset high	-9999~9999	0	万个	All
Pn037	原点位置偏移低位 Origin position offset low	-9999~9999	0	个	All
Pn038	原点回归第一速度 Origin regression first speed	1~3000	200	r/min	All
Pn039	原点回归第二速度 Origin regression second speed	1~3000	50	r/min	All
Pn040	原点回归加速时间 Origin regression acceleration time	5~10000	50	ms	All
Pn041	原点回归减速时间 Origin regression deceleration time	5~10000	50	ms	All
Pn042	原点在位延时 Origin on time delay	0~3000	100	ms	All
Pn043	原点回归完成信号延时 The origin regression completes the signal delay	5~3000	80	ms	All
Pn044	原点回归指令执行模式 Origin return instruction execution mode	0~1	0	-	All
Pn045	增益切换选择 Gain switching selection	0~5	0	-	All
Pn046	增益切换水平 Gain switching level	0~30000	80	-	All
Pn047	增益切换回差 Gain switching back difference	0~30000	6	-	All
Pn048	增益切换延迟时间 Gain switching delay time	0~20000	20	0.1ms	All
Pn049◆	增益切换时间 1 Gain switching time 1	0~15000	0	0.1ms	All

Pn050◆	增益切换时间 2 Gain switching time 2	0~15000	50	0.1ms	All
Pn051	电机运行最高速度限定 Maximum speed limit for motor operation	0~5000	3000	-	All
Pn052▲	SigIn1 端口功能分配 SigIn1 port function allocation	-31~31	1	-	All
Pn053▲	SigIn2 端口功能分配 SigIn2 port function allocation	-31~31	2	-	All
Pn054▲	SigIn3 端口功能分配 SigIn3 port function allocation	-31~31	19	-	All
Pn055▲	SigIn4 端口功能分配 SigIn4 port function allocation	-31~31	20	-	All
Pn056	SigIn1 端口滤波时间 SigIn1 port filtering time	1~1000	2	ms	All
Pn057	SigIn2 端口滤波时间 SigIn2 port filtering time	1~1000	2	ms	All
Pn058	SigIn3 端口滤波时间 SigIn3 port filtering time	1~1000	2	ms	All
Pn059	SigIn4 端口滤波时间 SigIn4 port filtering time	1~1000	2	ms	All
Pn060▲	SigOut1 端口功能分配 SigOut1 port function allocation	-14~14	2	-	All
Pn061▲	SigOut2 端口功能分配 SigOut2 port function allocation	-14~14	1	-	All
Pn062▲	SigOut3 端口功能分配 SigOut3 port function allocation	-14~14	4	-	All
Pn063▲	SigOut4 端口功能分配 SigOut4 port function allocation	-14~14	3	-	All
Pn064▲	通信方式 communication mode	0~2	2	-	All
Pn065	通信站点 Communication station	1~254	1	-	All
Pn066▲	通信波特率 Communication baud rate	0~5	5	-	All
Pn067▲	通信模式设定 Communication mode setting	0~8	8	-	All

Pn068	输入功能控制方式选择寄存器 1 The input function control mode selects the register 1	0~32767	0	-	All
Pn069	输入功能控制方式选择寄存器 2 The input function control mode selects the register 2	0~32767	0	-	All
Pn070	输入功能逻辑状态设置寄存器 1 Input function logic status setting register 1	0~32767	32691	-	All
Pn071	输入功能逻辑状态设置寄存器 2 Input function logic status setting register 2	0~32767	32767	-	All
Pn072	输入功能控制方式选择寄存器 3 Input function logic status setting register 3	0~1	0	-	All
Pn073	输入功能逻辑状态设置寄存器 3 Input function logic status setting register 3	0~1	1	-	All
Pn074	风扇开启温度 Fan opening temperature	30~70	50	摄氏度 Centigrade	All
Pn075	风扇运行方式 Fan operation mode	0~2	0	-	All
Pn076	紧急停机(EMG)复位方式 Emergency shutdown (EMG) reset mode	0~1	0	-	All
Pn077	正/反驱动禁止检出 Positive / reverse drive forbidden detection	0~2	0	-	All
Pn078	电压不足检出 Undervoltage detection	0~1	1	-	All
Pn079	系统状态显示项目选择 System status display project selection	0~30	0	-	All
Pn080▲	增量式编码器线数 Incremental encoder line number	0~16000	0	线 line	All
Pn081	用户参数永久写入操作 User parameter permanent write operation	0~1	0	-	All

Pn082	SigOut 端口强制输出 SigOut port forced output	0~4095	0	-	All
Pn083	低压报警检测幅值 Low voltage alarm detection amplitude	50~280	200	V	All
Pn084	高温报警检测幅值 High temperature alarm detection amplitude	0~100	70	摄氏度	All
Pn085▲	电机极对数 Pole count of motor	0~100	0	对	All
Pn086	内部使用 Internal use	-	-	-	-
Pn087▲	制动电阻选择 Selection of braking resistance	0~2	1	-	All
Pn088	制动电阻再生过载报警水平 Brake resistor regeneration overload alarm level	50~250	90	%	All
Pn089▲	外置制动电阻功率 External braking resistance power	20~20000	100	W	All
Pn090▲	外置制动电阻阻值 External braking resistance value	10~1000	100	Ω	All
Pn091	外置制动电阻再生可用容量 External brake resistance, regeneration, available capacity	5~100	20	%	All
Pn092	制动电阻过载检出 Overload detection of braking resistor	0~1	1	-	All
Pn093~Pn095	内部使用 Internal use	-	-	-	-

4.2.2 位置控制参数 Position control parameter

编号 NO.	名称 Name	取值范围 Range of values	默认值 Default value	单位 Unit	适用 apply
Pn096▲	指令脉冲输入方式 Command pulse input mode	0~2	0	-	P
Pn097▲	指令脉冲输入方向逻辑选择	0~1	0	-	P

	Instruction pulse input direction logic selection				
Pn098	脉冲电子齿轮比之分子 1 Pulse electron gear ratio of molecule 1	1~32767	1	-	P
Pn099	脉冲电子齿轮比之分子 2 Pulse electron gear ratio of molecule 2	1~32767	1	-	P
Pn100	脉冲电子齿轮比之分子 3 Pulse electron gear ratio of molecule 3	1~32767	1	-	P
Pn101	脉冲电子齿轮比之分子 4 Pulse electron gear ratio of molecule 4	1~32767	1	-	P
Pn102▲	脉冲电子齿轮比之分母 The denominator of a pulsed electronic gear ratio	1~32767	1	-	P
Pn103	位置偏差超出范围设定 The position deviation is out of range setting	1~ 2000	500	万个 ten thous and	P
Pn104	位置定位完成范围设定 Location setting	0~ 32767	10	个	P
Pn105	位置定位完成回差设定 Position setting complete backlash setting	0~ 32767	3	个	P
Pn106	位置定位接近范围设定 Location approach range setting	0~ 32767	300	个	P
Pn107	位置定位接近回差设定 Location approach back difference setting	0~ 32767	30	个	P
Pn108	位置偏差清除方式 Position deviation clearing mode	0~1	1	-	P
Pn109◆	位置指令加减速方式 Position command acceleration and deceleration mode	0~2	0	-	P
Pn110◆	位置指令一次滤波时间常数 Position instruction, primary filtering, time constant	5~500	50	ms	P

Pn111◆	位置指令 S 形滤波时间常数 Ta Position instruction, S shape filtering, time constant Ta	5~340	50	ms	P
Pn112◆	位置指令 S 形滤波时间常数 Ts Position instruction, S shape filtering, time constant Ts	5~150	20	ms	P
Pn113	位置环前馈增益 Position loop feedforward gain	0~100	0	%	P
Pn114▲	位置环前馈滤波器时间常数 Position loop, feedforward filter, time constant	1~50	5	ms	P
Pn115	位置调节器增益 1 Position regulator gain 1	1~2000	100	1/S	P
Pn116	位置调节器增益 2 Position regulator gain 2	1~2000	100	1/S	P
Pn117	位置指令源选择 Location command source selection	0~3	0	-	P
Pn118	内部位置指令暂停方式选择 Internal position instruction pause mode selection	0~1	0	-	P
Pn119	内部位置暂停减速时间 Internal position suspension deceleration time	0~10000	50	ms	P
Pn120	内部位置指令 0 脉冲数高位设定 Internal position command 0 pulse number high setting	-9999~9999	0	万个	P
Pn121	内部位置指令 0 脉冲数低位设定 Internal position command 0 pulse number low setting	-9999~9999	0	个	P
Pn122	内部位置指令 1 脉冲数高位设定 Internal position command 1 pulse number high setting	-9999~9999	0	万个	P
Pn123	内部位置指令 1 脉冲数低位设定 Internal position command 1 pulse	-9999~9999	0	个	P

	number low setting				
Pn124	内部位置指令 2 脉冲数高位设定 Internal position command 2 pulse number high setting	-9999~9999	0	万个	P
Pn125	内部位置指令 2 脉冲数低位设定 Internal position command 2 pulse number low setting	-9999~9999	0	个	P
Pn126	内部位置指令 3 脉冲数高位设定 Internal position command 3 pulse number high setting	-9999~9999	0	万个	P
Pn127	内部位置指令 3 脉冲数低位设定 Internal position command 3 pulse number low setting	-9999~9999	0	个	P
Pn128	内部位置指令 0 运行速度 Internal position instruction 0 running speed	0~3000	100	r/min	P
Pn129	内部位置指令 1 运行速度 Internal position instruction 1 running speed	0~3000	100	r/min	P
Pn130	内部位置指令 2 运行速度 Internal position instruction 2 running speed	0~3000	100	r/min	P
Pn131	内部位置指令 3 运行速度 Internal position instruction 3 running speed	0~3000	100	r/min	P
Pn132	转矩/速度控制切换至位置控制的方式 Torque / speed control switching to position control	0~1	0	-	P
Pn133	转矩/速度控制切换至位置控制的减速 时间 Torque / speed control switching to position control deceleration time	5~10000	100	ms	P
Pn134	定长位移方向 Fixed length	0~1	0	-	P

	displacement direction				
Pn135	定长位移高位 Fixed length shift height	0~9999	0	万个	P
Pn136	定长位移低位 Fixed length shift low	0~9999	100	个	P
Pn137	定长最高运行速度 Maximum running speed at fixed length	5~5000	200	r/min	P
Pn138	定长锁定解除方式 Fixed length locking release	0~1	1	-	P
Pn139	停止时振动抑制衰减比 Vibration suppression ratio at stop	10~100	100	%	P
Pn140	停止时振动抑制等待时间 The wait time is suppressed when the vibration is stopped	0~30000	300	ms	P
Pn141	停止时振动抑制条件 Vibration suppression conditions at stop	0~10000	10	脉冲 pulse	P
Pn142~Pn145	内部使用 Internal use	-	-	-	-

4.2.3 速度控制参数 Speed control parameter

编号 No.	名称 Name	取值范围 Range of values	默认值 Default value	单位 Unit	适用 Apply
Pn146◆	速度指令加减速方式 Speed command plus deceleration mode	0~2	1	-	S
Pn147◆	速度指令 S 曲线加减速时间常数 Ts Speed command, S curve, acceleration and deceleration time constant Ts	5~1500	80	ms	S
Pn148◆	速度指令 S 曲线加速时间常数 Ta Speed command, S curve, acceleration time constant, Ta	5~10000	80	ms	S
Pn149◆	速度指令 S 曲线减速时间常数 Td Speed command, S curve,	5~10000	80	ms	S

	deceleration time constant Td				
Pn150◆	直线加速时间常数 Linear acceleration time constant	5~30000	80	ms	S
Pn151◆	直线减速时间常数 Linear deceleration time constant	5~30000	80	ms	S
Pn152▲	速度检测滤波时间常数 Speed detection filter time constant	1~380	1	0.1ms	All
Pn153	速度调节器比例增益 1 Speed regulator proportional gain 1	1~2000	80	Hz	All
Pn154	速度调节器积分时间常数 1 Speed regulator integration time constant 1	1~5000	150	0.1ms	All
Pn155	速度调节器比例增益 2 Speed regulator proportional gain 2	1~2000	80	Hz	All
Pn156	速度调节器积分时间常数 2 Speed regulator integration time constant 2	1~5000	150	0.1ms	All
Pn157▲	模拟速度指令平滑过滤时间 Simulated speed, instruction smoothing, filtering time	1~500	1	0.1ms	S
Pn158	模拟速度指令增益 Analog speed command gain	1~1500	300	r/min/V	S
Pn159	模拟速度指令偏移调整 Analog speed shift adjustment	-5000~5000	0	mv	S
Pn160	模拟速度指令方向 Analog speed direction	0~1	0	-	S
Pn161	模拟速度指令强制零区间上限 Analog speed command force zero interval upper limit	0~1000	0	10mv	S
Pn162	模拟速度指令强制零区间下限 Analog speed command forced zero interval lower bound	-1000~0	0	10mv	S
Pn163	零速箝位锁定方式 Zero speed	0~1	0	-	S

	clamping lock mode				
Pn164	零速箝位触发方式 Zero speed clamping trigger mode	0~1	0	-	S
Pn165	零速箝位电平 Zero speed clamping level	0~200	6	r/min	S
Pn166	零速箝位减速时间 Zero speed clamping deceleration time	5~10000	50	ms	S
Pn167	内部位置调节器增益 Internal position regulator gain	1~2000	100	1/S	All
Pn168	速度指令来源选择 Speed command source selection	0~2	0	-	S
Pn169	内部速度指令 1 Internal speed command 1	-5000~5000	0	r/min	S
Pn170	内部速度指令 2 Internal speed command 2	-5000~5000	0	r/min	S
Pn171	内部速度指令 3 Internal speed command 3	-5000~5000	0	r/min	S
Pn172	内部速度指令 4 Internal speed command 4	-5000~5000	0	r/min	S
Pn173	内部速度指令 5 Internal speed command 5	-5000~5000	0	r/min	S
Pn174	内部速度指令 6 Internal speed command 6	-5000~5000	0	r/min	S
Pn175	内部速度指令 7 Internal speed command 7	-5000~5000	0	r/min	S
Pn176	内部速度指令 8 Internal speed command 8	-5000~5000	0	r/min	S
Pn177	JOG 速度 JOG speed	0~5000	200	r/min	S
Pn178	JOG 加速时间 JOG Acceleration time	5~ 10000	100	ms	S
Pn179	JOG 减速时间 JOG Deceleration time	5~ 10000	100	ms	S
Pn180~ Pn181	内部使用 Internal use	-	-	-	-

Pn182◆	速度环 PDFF 控制系数 Speed loop PDFF control factor	0~100	100	-	PS
Pn183~	速度反馈补偿 Speed feedback compensation	0~100	0	%	PS
Pn184~ Pn185	内部使用 Internal use	-	-	-	-

4.2.4 转矩控制参数 Torque control parameter

编号 NO. .	名称 Name	取值范围 Range of values	默认值 Default value	单位 Unit	适用 Apply
Pn186	转矩指令加减速方式 Torque command acceleration and deceleration mode	0~1	0	-	T
Pn187▲	转矩指令直线加减速时间常数 Torque command linear acceleration and deceleration time constant	1~30000	1	ms	T
Pn188▲	模拟转矩指令平滑过滤时间 Simulated torque command smoothing filtering time	1~500	5	0.1ms	T
Pn189	模拟转矩指令增益 Analog torque command gain	1~300	30	%/V	T
Pn190	模拟转矩指令偏移调整 Analog torque command offset adjustment	-1500~1500	0	mv	T
Pn191	模拟转矩指令方向 Analog torque direction	0~1	0	-	T
Pn192	转矩 Q 轴调节器比例增益 1 Torque Q shaft regulator proportional gain 1	5~ 2000	100	%	All
Pn193	转矩 Q 轴调节器积分时间常数 1 Torque Q axis regulator	5~ 2000	100	%	All

	integration time constant 1				
Pn194	转矩 Q 轴调节器比例增益 2 Torque Q shaft regulator proportional gain 2	5~2000	100	%	All
Pn195	转矩 Q 轴调节器积分时间常数 2 Torque Q axis regulator integration time constant 2	5~2000	100	%	All
Pn196	转矩指令滤波时间常数 1 Torque instruction filtering time constant 1	1~5000	40	0.01ms	All
Pn197	转矩指令滤波时间常数 2 Torque instruction filtering time constant 2	1~5000	40	0.01ms	All
Pn198	转矩控制时限制速度 Limiting speed during torque control	0~4500	2500	r/min	T
Pn199	转矩控制受限速度来源选择 Torque control, limited speed, source selection	0~2	0	-	T
Pn200	内部转矩 1 Internal torque 1	-300~300	0	%	T
Pn201	内部转矩 2 Internal torque 2	-300~300	0	%	T
Pn202	内部转矩 3 Internal torque 3	-300~300	0	%	T
Pn203	内部转矩 4 Internal torque 4	-300~300	0	%	T
Pn204	转矩指令来源 Torque command source	0~2	0	-	T
Pn205	转矩 D 轴调节器比例增益 Torque D axis regulator; proportional gain	5~2000	100	%	All
Pn206	转矩 D 轴调节器积分时间常数 Torque D axis regulator, integral time constant	5~2000	100	%	All
Pn207	速度反馈调节系数 Speed feedback adjustment factor	1~3000	100	-	T
Pn208	跟踪转矩指令判断误差范围 1 Tracking torque instruction to	0~300	5	%	T

	determine range of error 1				
Pn209	跟踪转矩指令判断误差范围 2 Tracking torque instruction to determine range of error 2	0~300	2	%	T
Pn210	速度限制输出的判定时间 Decision time for speed limited output	0~2000	15	ms	T
Pn211~ Pn215	内部使用 Internal use	-	-	-	-

4.2.5 扩展控制参数 Extended control parameter

编号 NO.	名称 Name	取值范围 Range of values	默认值 Default value	单位 Unit	适用 Apply
Pn216▲	绝对式编码器用法选择 Absolute encoder usage selection	0~1	1	-	All
Pn217	绝对式编码器输出线数 Absolute encoder output line	16~16384	2500	线 line	All
Pn218	绝对式编码器绝对位置数据发送方式 Absolute position data transfer mode for absolute encoder	0~1	0	-	All
Pn219	绝对式编码器多圈溢出检出 Multi turn overflow detection for absolute encoder	0~1	1	-	All
Pn220▲	SigIn5 端口功能分配 SigIn5 port function allocation	-31~31	3	-	All
Pn221▲	SigIn6 端口功能分配 SigIn6 port function allocation	-31~31	4	-	All
Pn222▲	SigIn7 端口功能分配 SigIn7 port function allocation	-31~31	9	-	All
Pn223▲	SigIn8 端口功能分配 SigIn8 port function allocation	-31~31	10	-	All
Pn224▲	SigIn9 端口功能分配 SigIn9 port function allocation	-31~31	11	-	All

Pn225▲	SigIn10 端口功能分配 SigIn10 port function allocation	-31~31	0	-	All
Pn226	SigIn5 端口滤波时间 SigIn5 port filtering time	1~1000	2	ms	All
Pn227	SigIn6 端口滤波时间 SigIn6 port filtering time	1~1000	2	ms	All
Pn228	SigIn7 端口滤波时间 SigIn7 port filtering time	1~1000	2	ms	All
Pn229	SigIn8 端口滤波时间 SigIn8 port filtering time	1~1000	2	ms	All
Pn230	SigIn9 端口滤波时间 SigIn90 port filtering time	1~1000	2	ms	All
Pn231	SigIn10 端口滤波时间 SigIn10 port filtering time	1~1000	2	ms	All
Pn232▲	SigOut5 端口功能分配 SigOut5 port function allocation	-14~14	9	-	All
Pn233	内部使用 Internal use	-	-	-	-
Pn234	脉冲指令最高频率 Maximum pulse command frequency	20~2000	550	KHZ	P
Pn235	脉冲指令数字滤波时间 Pulse instruction digital filtering time	0~255	0	100ns	P
Pn236~ Pn239	内部使用 Internal use	-	-	-	-
Pn240	绝对式编码器正向软禁止多圈值 Absolute encoder, forward soft forbidden, multi circle value	0~32000	0	圈 circle	All
Pn241	绝对式编码器正向软禁止单圈值 Absolute encoder, forward soft forbidden, single coil value	0~9999	0	0.0001 圈 circle	All
Pn242	绝对式编码器反向软禁止多圈值 Absolute encoder, reverse soft forbidden, multi circle value	0~32000	0	圈 circle	All
Pn243	绝对式编码器反向软禁止单圈值	0~9999	0	0.0001 圈	All

	Absolute encoder, reverse soft inhibit, single coil value			circle	
Pn244	原点回归定位接近范围 Origin, regression, positioning, approach range	0~3000	20	个	All
Pn245~ Pn256	内部使用 Internal use	-	-	-	-
Pn257	负载转动惯量比 Load inertia ratio	0.00~100.0 0	1.00	倍 times	PS
Pn258	增益调整模式 Gain adjustment mode	0~1	0	-	PS
Pn259	刚性等级选择 Rigid grade selection	0~20	5	-	PS
Pn260	惯量实时推定方式 Real-time estimation method of inertia	0~1	0	-	All
Pn260~ Pn262	内部使用 Internal use	-	-	-	-
Pn263◆	惯量推定加减速时间 Inertia estimation acceleration and deceleration time	20~500	80	ms	All
Pn264◆	惯量推定允许最高速度 Inertia estimation allows maximum speed	150~1000	400	r/min	All
Pn265◆	惯量推定暂停时间间隔 Inertia estimation pause interval	0~10000	500	ms	All
Pn266◆	惯量推定惯量比预估值 Inertia estimation; inertia ratio; prediction value	1.00~20.00	3.00	倍 times	All
Pn267▲	电机额定转矩 Rated torque of motor	0~320.00	0	N·m	All
Pn268▲	电机最大输出转矩 Maximum output torque of motor	0~300.00	0	倍 times	All
Pn269▲	电机转动惯量 Motor moment of inertia	0~320.00	0	$\text{Kg} \cdot \text{m}^2 \cdot 10^{-4}$	All
Pn270▲	电机力矩系数 Motor torque coefficient	0~100.00	0	N·m/Arms	All
Pn271▲	电机最大转速 Maximum motor speed	80~5500	80	r/min	All
Pn272~	内部使用 Internal use	-	-	-	-

Pn275					
Pn276	开启可编程运动控制器 Open programmable motion controller	0~1	0	-	All
Pn277~Pn280	内部使用 Internal use	-	-	-	-

4.3 参数详解 Parameter detail

4.3.1 系统参数 system parameter

编号 NO.	名称 Name	取值范围 Range of values	默认值 Default value	单位 Unit	适用 Apply
Pn000	参数编辑与初始化 Parameter editing and initialization	0~3	1		All
	设定值 Setting value	功能 function			
	0	禁止参数初始化 Parameter initialization prohibited			
	1	允许参数初始化，但不初始化 Pn001, Pn080, Pn159, Pn190 等与应用无关的功能参数。Allows parameter initialization, but does not initialize Pn001, Pn080, Pn159, Pn190, and other application independent functional parameters.			
	2	恢复出厂前设置。Restore settings before shipment.			
	3	按键查看模式，无法修改参数。Press button to view mode and cannot modify parameters.			

编号 No.	名称 Name	取值范围 Range of values	默认值 Default value	单位 Unit	适用 Apply
Pn001▲	电机代码 Motor code	0-70	7		All
	须设置与电机相配套的电机代码，电机才能正常工作。The motor code must be set up with the motor, so that the motor can work properly.				

220V 驱动器型号与电机型号适配表如下：The 220V drive model and the motor model adaptation sheet are as follows:

电机型号 Motor mode	Pn001	额定转速 Rated speed (r/min)	额定转矩 Rated torque (N.M)	额定功率 Rated power (KW)	KRS 15	KRS 20A	KRS 30A	KRS 50A	KRS 75A
60st_m00630	0	3000	0.6	0.2	√	√	√		
60st_m01330	1	3000	1.3	0.4	√	√	√		
60st_m01930	2	3000	1.9	0.6	√	√	√		
80st_m01330	3	3000	1.3	0.4	√	√	√		
80st_m02430	4	3000	2.4	0.75	√	√	√		
80st_m03520	5	2000	3.5	0.73	√	√	√		
80st_m04025	6	2500	4	1	√	√	√		
90st_m02430	7	3000	2.4	0.75	√	√	√		
90st_m03520	8	2000	3.5	0.73	√	√	√		
90st_m04025	9	2500	4	1	√	√	√		
110st_m02030	10	3000	2	0.6	√	√	√		
110st_m04020	11	2000	4	0.8	√	√	√		
110st_m04030	12	3000	4	1.2		√	√		
110st_m05030	13	3000	5	1.5			√		
110st_m06020	14	2000	6	1.2	√	√	√		
110st_m06030	15	3000	6	1.8			√		
130st_m04025	16	2500	4	1	√	√	√		
130st_m06015	17	1500	6	1	√	√	√		
130st_m05025	18	2500	5	1.3		√	√		
130st_m06025	19	2500	6	1.5			√		
130st_m07725	20	2500	7.7	2			√		
130st_m10010	21	1000	10	1	√	√	√		
130st_m10015	22	1500	10	1.5		√	√		
130st_m10025	23	2500	10	2.6			√	√	√
130st_m15015	24	1500	15	2.3			√		
130st_m15025	25	2500	15	3.8				√	√
150st_m15025	26	2500	15	3.8				√	√

150st_m15020	27	2000	15	3				√	√
150st_m18020	28	2000	18	3.6				√	√
150st_m23020	29	2000	23	4.7				√	√
150st_m27020	30	2000	27	5.5					√
180st_m17215	31	1500	17.2	2.7				√	√
180st_m19015	32	1500	19	3			√	√	√
180st_m21520	33	2000	21.5	4.5				√	√
180st_m27010	34	1000	27	2.9				√	√
220st_m67010	35	1000	67	7					√
180st_m35015	37	1500	35	5.5					√
40st_m00330	39	3000	0.3	0.1	√	√	√		

380V 驱动器型号与电机型号适配表如下：The 380V drive model and the motor model adaptation sheet are as follows:

电机型号 Motor mode	Pn001	额定转速 Rated speed (r/min)	额定转矩 Rated torque (N.M)	额定功率 Rated power (KW)	KRS 25	KRS 40	KRS 50	KRS 75
180st_m48020	46	2000	48	10			√	√
180st_m19020	47	2000	19	4		√	√	√
180st_m35020	48	2000	35	7.3		√	√	√
180st_m27020	49	2000	27	5.6		√	√	√
180st_m48015	50	1500	48	7.5			√	√
180st_m19015	51	1500	27	3		√	√	√
180st_m21520	52	2000	27	4.5		√	√	√
180st_m27010	53	1000	27	2.9		√	√	√
180st_m27015	54	1500	27	4.3		√	√	√
180st_m35010	55	1000	35	3.7		√	√	√
180st_m35015	56	1500	35	5.5		√	√	√

编号 NO.	名称 Name	取值范围 Range of	默认值	单位 Unit	适用
--------	---------	---------------	-----	---------	----

		values	Default value		Apply														
Pn002▲	控制模式 Control mode	0~5	2		All														
	<table border="1"> <thead> <tr> <th>设定值 Setting value</th> <th>控制模式 control mode</th> </tr> </thead> <tbody> <tr> <td>0</td> <td>转矩模式 Torque mode</td> </tr> <tr> <td>1</td> <td>速度模式 Speed mode</td> </tr> <tr> <td>2</td> <td>位置模式 Location mode</td> </tr> <tr> <td>3</td> <td>位置/速度模式 Position / speed mode</td> </tr> <tr> <td>4</td> <td>位置/转矩模式 Position / torque mode</td> </tr> <tr> <td>5</td> <td>速度/转矩模式 Speed / torque mode</td> </tr> </tbody> </table> <p>• 设置为 3, 4, 5 时, 模式之间的切换由输入端口 SigIn 的 Cmode 信号状态决定。 When set to 3, 4, and 5, switching between modes is determined by the Cmode signal status of the input port SigIn.</p> <p>• 控制模式切换方式详见附录 B For control mode switching, see Appendix B</p>					设定值 Setting value	控制模式 control mode	0	转矩模式 Torque mode	1	速度模式 Speed mode	2	位置模式 Location mode	3	位置/速度模式 Position / speed mode	4	位置/转矩模式 Position / torque mode	5	速度/转矩模式 Speed / torque mode
	设定值 Setting value	控制模式 control mode																	
0	转矩模式 Torque mode																		
1	速度模式 Speed mode																		
2	位置模式 Location mode																		
3	位置/速度模式 Position / speed mode																		
4	位置/转矩模式 Position / torque mode																		
5	速度/转矩模式 Speed / torque mode																		

编号 No.	名称 Name	取值范围 Range of values	默认值 Default value	单位 Unit	适用 Apply
Pn003	伺服使能方式 Servo enable mode	0~1	0		All
	设置值 Setting value	功能 function			
	0	由输入端口 SigIn 的 SON 使能驱动器 The SON enable drive from the input port SigIn			
	1	上电后自动使能驱动器 Automatically enable drive after power on			

编号 No.	名称 Name	取值范围	默认值	单位 Unit	适用
--------	---------	------	-----	---------	----

		Range of values	Default value		Apply
Pn004	伺服断使能停机方式 Servo disconnect enable shutdown mode	0~2	0		All
	当使能信号变从有效变为无效时, 可设置电机停止运行的方式: When the enable signal changes from valid to invalid, the motor can be stopped operating:				
	设置值 Setting value	电磁制动器 Electromag netic brake	减速停机 Deceleration stop	说明 Explain	
	0	不使用 Not used	不使用 Not used	惯性停车 Inertia stop	
1	不使用 Not used	使用 Use	减速停车, 减速时间由 Pn005 确定 Slow down and stop. The deceleration time is determined by Pn005		
2	使用 Use	不使用 Not used	电磁制动方式停车 (适用带有电磁制动器的电机) Electromagnetic braking mode parking (suitable for motors with electromagnetic brakes)		

编号 No.	名称 Name	取值范围 Range of values	默认值 Default value	单位 Unit	适用 Apply
Pn005	断使能减速时间 Break down to slow down	5-10000	100	ms	All
使能信号从有效变为无效时, 使电机减速至零的时间。在减速过程中, 若使能信号再次有效, 电机仍会先减速至零 When the signal is changed from valid to invalid, the motor is slowed down to zero. In the deceleration process, if the enable signal is effective again, the motor will slow down to zero					

编号 No.	名称 Name	取值范围 Range of values	默认值 Default value	单位 Unit	适用 Apply														
Pn006	使用/不使用正反驱动禁止 Use / do not use positive and negative drive prohibited	0-3	0		All														
	<p>设置本参数值，可以选择使用或不使用驱动禁止功能，其真值表如下：To set the parameter value, you can choose to use or not use the drive disable function. The truth table is as follows:</p> <table border="1" style="margin-left: auto; margin-right: auto;"> <thead> <tr> <th>设置值 Setting value</th> <th>正转驱动禁止 Forward drive inhibit</th> <th>反转驱动禁止 Reverse drive inhibit</th> </tr> </thead> <tbody> <tr> <td>0</td> <td>不使用 Not used</td> <td>不使用 Not used</td> </tr> <tr> <td>1</td> <td>不使用 Not used</td> <td>使用 Use</td> </tr> <tr> <td>2</td> <td>使用 Use</td> <td>不使用 Not used</td> </tr> <tr> <td>3</td> <td>使用 Use</td> <td>使用 Use</td> </tr> </tbody> </table>					设置值 Setting value	正转驱动禁止 Forward drive inhibit	反转驱动禁止 Reverse drive inhibit	0	不使用 Not used	不使用 Not used	1	不使用 Not used	使用 Use	2	使用 Use	不使用 Not used	3	使用 Use
设置值 Setting value	正转驱动禁止 Forward drive inhibit	反转驱动禁止 Reverse drive inhibit																	
0	不使用 Not used	不使用 Not used																	
1	不使用 Not used	使用 Use																	
2	使用 Use	不使用 Not used																	
3	使用 Use	使用 Use																	

编号 No.	名称 Name	取值范围 Range of values	默认值 Default value	单位 Unit	适用 apply
Pn007	正/反驱动禁止停机减速时间 Positive / reverse drive, no stopping, deceleration time	0-10000	60	ms	All
	<p>当发生超程时，SigIn 端口的 ccwl 或 cwl 状态为 OFF，使用 Pn077 可设置是否进行报警检出。超程时，电机可按照减速时间减速，同时清除位置指令脉冲（位置控制），停止后进行内部位置锁定。内部位置增益通过 Pn167 调节。When a overrun occurs, the SigIn port is either ccwl or CWL, and Pn077 is used to set the OFF alarm. Over time, the motor can decelerate in accordance with the deceleration time, while clearing the position command pulse (position control), after stopping, the internal position is locked. The internal position gain is adjusted via</p>				

	the Pn167.
--	------------

编号 No.	名称 Name	取值范围 Range of values	默认值 Default value	单位 Unit	适用 Apply
Pn008	内部正转转矩限制 (CCW) Internal forward torque limit (CCW)	0-300	300	%	All
Pn009	内部反转转矩限制 (CW) Internal reverse torque limit (CW)	-300~0	-300	%	All
Pn010	外部正转转矩限制 (CCW) External forward torque limit (CCW)	0-300	300	%	All
Pn011	外部反转转矩限制 (CW) External reverse torque limit (CW)	-300~0	-300	%	All
	<ul style="list-style-type: none"> • 设置电机 CCW/CW 方向的转矩限制。内、外部转矩限制同时有效时，实际转矩取较小限制值。• set the torque limit in the motor CCW/CW direction. When the internal and external torque limits are in effect, the actual torque is taken as a smaller limit. • 外部转矩限制由 SigIn 端口的 TCCWL、TCWL 控制。the external torque limit is controlled by the SigIn port TCCWL and TCWL. • 有些电机最大输出转矩是额定转矩的两倍，则电机输出的最大转矩自动受限于两倍额定转矩以内。The maximum output torque of some motors is two times the rated torque, and the maximum torque output of the motor is limited to two times the rated torque automatically. 				

编号 No.	名称 Name	取值范围 Range of values	默认值 Default value	单位 Unit	适用 Apply
Pn012	正转 (CCW) 转矩过载 1 报警水平 Forward (CCW)	0-300	200	%	All

	torque overload 1 alarm level				
Pn013	反转 (CW) 转矩过载 1 报警水平 Reverse (CW) torque overload 1 alarm level	-300-0	-200	%	All
Pn014	转矩过载 1 报警检测时间 Torque overload 1 alarm detection time	1-900	250	100ms	All
Pn015	过载 2 检测时间 Overload 2 detection time	1-300	80	100ms	All
<ul style="list-style-type: none"> • 过载 1 报警水平指过载过流相对于电机额定输出电流的百分比，过载能力的范围在 0 与最大输出电流之间。过载 1 的过载能力默认为 2 倍扭矩，在设定的时间内，若持续超过 2 倍输出扭矩，将执行过载 1 保护。Overload 1 alarm level refers to the percentage of overload overcurrent relative to the rated output current of the motor. The overload capacity is between 0 and the maximum output current. Overload 1 overload capacity defaults to 2 times torque, in the set time, if more than 2 times the output torque, will perform overload 1 protection. • 在设定的时间内，电机达到允许的额定扭矩输出倍数时，将执行过载 2 保护。During the set time, when the motor reaches the rated torque output multiples, the overload 2 protection will be carried out. • 若过载水平设置大于相应的内/外部转矩限制值时，过载条件可能得不到满足，保护将起不到作用。If the overload level setting is greater than the corresponding internal / external torque limit values, overload conditions may not be met and protection will not work. 					

编号 No.	名称 Name	取值范围 Range of values	默认值 Default value	单位 Unit	适用 Apply
Pn016▲	增量式编码器分频输出之分子 DA Molecular DA for frequency division	1~127	1		All

	output of an incremental encoder				
Pn017▲	增量式编码器分频输出之分母 DB The denominator of frequency division output of incremental encoder DB	1~127	1		All
	<p>增量式编码器输出电子齿比，用于对编码器脉冲信号进行分频输出，仅适用于带有增量式编码器的伺服单元。分频值必须满足：$DA/DB \geq 1$。例如，编码器为 2500 线，分频值 $DA/DB=25/8$，则分频后的线数：$2500/(DA/DB)=2500/(25/8)=800$ 线。The output ratio of the incremental encoder is used to segment the pulse signal of the encoder, and only applies to the servo unit with incremental encoder. Frequency division must be satisfied: $DA/DB \geq 1$. For example, the encoder is 2500 lines and the frequency division value is $DA/DB=25/8$. Then the number of lines after dividing is $2500/(DA/DB) = 2500/(25/8) = 800$ lines.</p>				

编号 No.	名称 Name	取值范围 Range of values	默认值 Default value	单位 Unit	适用 Apply			
Pn018▲	编码器输出脉冲 AB 相位逻辑取反 Encoder output pulse AB phase logic inversion	0-1	0		All			
		<table border="1"> <thead> <tr> <th>设置值 Setting value</th> <th>功能 Function</th> </tr> </thead> <tbody> <tr> <td>0</td> <td>电机逆时针旋转 A 超前 B; 顺时针旋转 B 超前 A The motor counter clockwise rotation A ahead B; clockwise rotation before B ultrasonic A</td> </tr> </tbody> </table>	设置值 Setting value	功能 Function	0	电机逆时针旋转 A 超前 B; 顺时针旋转 B 超前 A The motor counter clockwise rotation A ahead B; clockwise rotation before B ultrasonic A		
设置值 Setting value	功能 Function							
0	电机逆时针旋转 A 超前 B; 顺时针旋转 B 超前 A The motor counter clockwise rotation A ahead B; clockwise rotation before B ultrasonic A							

		1	电机逆时针旋转 B 超前 A; 顺时针旋转 A 超前 B The motor rotates counterclockwise A before the B ultrasonic; clockwise rotation A ahead of B	
--	--	---	---	--

编号 No.	名称 Name	取值范围 Range of values	默认值 Default value	单位 Unit	适用 Apply
Pn019▲	额定电流设置 Rated current setting	0.0-100.0	0	Arms	All
Pn020▲	额定转速设置 Rated speed setting	0~5000	额定转速	r/min	All
<p>参数设置为 0, 则使用厂家设置的默认值; 否则, 用户必须严格依照电机的额定电流有效值和额定速度及相应的内部正反转矩限制值设置参数值。若设置不当, 电机将不能正常运转。依据驱动器型号及电机代码的不同, 可达到的最大实际电流值不同。一般用户请勿修改</p> <p>If the parameter is set to 0, the default value set by the manufacturer is used; otherwise, the user must set the parameter value strictly according to the rated current, the effective value and the rated speed of the motor and the corresponding internal and forward torque limit values. The motor will not operate properly if it is improperly set up. Depending on the drive type and the motor code, the maximum actual current value available is different. General users, please do not modify</p>					

编号 No.	名称 Name	取值范围 Range of values	默认值 Default value	单位 Unit	适用 Apply
Pn021	到达预定速度 Reach a predetermined speed	0~5000	500	r/min	All
Pn022	到达预定速度迟滞比较差值 Arrive at a predetermined speed, lag, compare	0~5000	30	r/min	All

	difference												
Pn023	到达预定速度检测方向 Arrive at a predetermined speed, direction of detection	0-2	0		All								
Pn023	<p>• 当电机的运行速度超过设定的判定值时，输出端口 SigOut 的 Sreach 将转变为 ON，否则为 OFF。 When the motor speed exceeds the set decision value, the Sreach of the output port SigOut will be converted to ON, otherwise OFF.</p> <p>• 比较器具有迟滞比较特性。差值设置值过小，输出信号关断频率越高；设置值越大，关断频率小，但同时导致比较器的分辨率降低。例：预定速度设置为 100，差值设置为 10。 The comparator has hysteresis comparison characteristics. The value of the difference setting is too small, the higher the output signal turn off frequency is, the larger the setting value is, the smaller the turn off frequency is, but at the same time the resolution of the comparator is reduced. Example: the preset speed is set to 100, and the difference is set to 10.</p> <div style="text-align: center;"> </div> <p>•可设置速度检测方向, 如下表: You can set the speed detection direction as follows:</p> <table border="1" style="width: 100%; border-collapse: collapse;"> <thead> <tr> <th style="width: 15%;">Pn023</th> <th style="width: 85%;">比较器 comparator</th> </tr> </thead> <tbody> <tr> <td style="text-align: center;">0</td> <td style="text-align: center;">正反转都检测 Reverse and reverse detection</td> </tr> <tr> <td style="text-align: center;">1</td> <td>只检测正转速度; 反转时, 信号为 OFF Only positive rotation speed is detected; when reversal, the signal is OFF</td> </tr> <tr> <td style="text-align: center;">2</td> <td>只检测反转速度; 正转时, 信号为 OFF The reverse speed is detected only. When the signal is positive, the signal is OFF</td> </tr> </tbody> </table>					Pn023	比较器 comparator	0	正反转都检测 Reverse and reverse detection	1	只检测正转速度; 反转时, 信号为 OFF Only positive rotation speed is detected; when reversal, the signal is OFF	2	只检测反转速度; 正转时, 信号为 OFF The reverse speed is detected only. When the signal is positive, the signal is OFF
Pn023	比较器 comparator												
0	正反转都检测 Reverse and reverse detection												
1	只检测正转速度; 反转时, 信号为 OFF Only positive rotation speed is detected; when reversal, the signal is OFF												
2	只检测反转速度; 正转时, 信号为 OFF The reverse speed is detected only. When the signal is positive, the signal is OFF												

编号 No.	名称 Name	取值范围 Range of values	默认值 Default value	单位 Unit	适用 Apply								
Pn024	到达预定转矩 Arrival torque	0-300	100	%	All								
Pn025	到达预定转矩迟滞比较差值 Lag difference between arrival torque and preset torque	0-300	5	%	All								
Pn026	到达预定转矩方向 Reach the desired torque direction	0-2	0		All								
<ul style="list-style-type: none"> 当电机的运行转矩超过设定的判定值时，输出端口 SigOut 的 Treach 将转变为 ON，否则为 OFF。 When the operating torque of the motor exceeds the set decision value, the Treach of the output port SigOut will be converted to ON, or not then OFF. 可设置转矩检测方向，如下表：Torque detection direction can be set as follows: <table border="1" style="margin-left: 40px;"> <thead> <tr> <th>Pn026</th> <th>比较器 comparator</th> </tr> </thead> <tbody> <tr> <td>0</td> <td>正反转都检测 Reverse and reverse detection</td> </tr> <tr> <td>1</td> <td>只检测正转转矩；反转时，信号为 OFF。Only positive torque is detected; when reversal, the signal is OFF.</td> </tr> <tr> <td>2</td> <td>只检测反转转矩；正转时，信号为 OFF。Reverse torque is detected only when the forward turn signal is OFF.</td> </tr> </tbody> </table>						Pn026	比较器 comparator	0	正反转都检测 Reverse and reverse detection	1	只检测正转转矩；反转时，信号为 OFF。Only positive torque is detected; when reversal, the signal is OFF.	2	只检测反转转矩；正转时，信号为 OFF。Reverse torque is detected only when the forward turn signal is OFF.
Pn026	比较器 comparator												
0	正反转都检测 Reverse and reverse detection												
1	只检测正转转矩；反转时，信号为 OFF。Only positive torque is detected; when reversal, the signal is OFF.												
2	只检测反转转矩；正转时，信号为 OFF。Reverse torque is detected only when the forward turn signal is OFF.												

编号 No.	名称 Name	取值范围 Range of values	默认值 Default value	单位 Unit	适用 Apply
Pn027	零速检测幅度设定 Zero velocity detection range set	0~1000	10	r/min	All
Pn028	零速检测回差 Zero speed test return error	0~1000	5	r/min	All
当电机运行速度低于设定的速度值时，输出端口 SigOut 的 zerospeed 转变为 ON，否					

	则为 OFF。When the motor speed is lower than the set speed value, the zerospeed of the output port SigOut is changed to ON, otherwise OFF.
--	---

编号 No.	名称 Name	取值范围 Range of values	默认值 Default value	单位 Unit	适用 Apply
Pn029	电机电磁制动零速检测点 Zero speed detection point of motor electromagnetic brake	0~1000	5	r/min	All
仅在使用电磁制动器功能时，判断电机是否为零速状态。Only when the electromagnetic brake function is used, will the motor be judged to be a zero speed state.					

编号 No.	名称 Name	取值范围 Range of values	默认值 Default value	单位 Unit	适用 Apply
Pn030	电机静止时电磁制动器延时时间 Delay time of electromagnetic brake when the motor is stationary	0~2000	0	Ms	All
<ul style="list-style-type: none"> 电机静止时，电磁制动器制动开始到电机切断电流的延时时间。When the motor is stationary, the electromagnetic brake starts the delay time of the motor to cut off the current. 使用电磁制动功能时，伺服断使能方式 Pn004 必须设置为 2。When using the electromagnetic braking function, the servo break enable mode Pn004 must be set to 2. 					

编号 No.	名称 Name	取值范围 Range of values	默认值 Default value	单位 Unit	适用 Apply
Pn031	电机运转时电磁制动器	0~2000	500	ms	All

	等待时间 When the motor is running, the electromagnetic brake wait time				
	电机运转时, 电机切断电流到电磁制动器制动之间的等待时间。When the motor is running, the motor breaks the current to the time between the brake of the electromagnetic brake.				

编号 No.	名称 Name	取值范围 Range of values	默认值 Default value	单位 Unit	适用 Apply
Pn032	电机运转时电磁制动器动作速度 The speed of the electromagnetic brake when the motor is running	0-3000	30	r/min	All
	电机运转时, 当电机低于此参数设定的速度时, 磁制动器开始制动。When the motor is running, when the motor is less than the speed set by this parameter, the magnetic brake starts to brake.				

编号 No.	名称 Name	取值范围 Range of values	默认值 Default value	单位 Unit	适用 Apply
	原点回归触发方式 Origin regression trigger mode	0~3	0		All

Pn033	设置值 Setting value	功能 function
	0	关闭原点回归功能 Turn off the origin regression function
	1	由输入端口 SigIn 的 GOH 电平触发 Triggered by the GOH level of the input port SigIn
	2	由输入端口 SigIn 的 GOH 上升沿触发 Triggered by the rising edge of the input port SigIn GOH
	3	上电自动执行 Automatic execution of power on
	<ul style="list-style-type: none"> • 原点回归执行方式详见附录 F。The origin regression method is shown in Appendix F. 	

编号 No.	名称 Name	取值范围 Range of values	默认值 Default value	单位 Unit	适用 Apply
Pn034	原点回归参考点模式 Origin regression reference point mode	0~6	0		All

设置值 Setting value	功能 Function
0	正转找 REF(上升沿触发)作参考点 The REF is turned (triggered by the rising edge) as the reference point
1	反转找 REF(上升沿触发)作参考点 Flip for REF (rising edge trigger) as reference point
2	正转找 CCWL(下降沿触发)作参考点 The CCWL is being turned (triggered by the falling edge) as the reference point
3	反转找 CWL(下降沿触发)作参考点 Reverse find CWL (drop edge trigger) as reference point
4	正转找 Z 脉冲作参考点 The Z pulse is being turned to the reference point
5	反转找 Z 脉冲作参考点 Turn the Z pulse for reference point
6	绝对零点作参考点 Absolute zero as reference point

注意: CCWL 或 CWL 作为参考点时, 需设置 Pn006 参数, 开启功能。Note: when CCWL or CWL is used as a reference point, you need to set the Pn006 parameter and turn on the function.

编号 No.	名称 Name	取值范围 Range of values	默认值 Default value	单位 Unit	适用 Apply
Pn035	原点回归原点模式 Origin regression origin mode	0~2	0		All
	设置值 Setting value	功能 Function			

	0	向后找 Z 脉冲作原点 Look for the origin of the Z pulse backwards
	1	向前找 Z 脉冲作原点 Look for the origin of the Z pulse forward
	2	直接以参考点上升沿作原点 The origin is raised directly at the rising edge of the reference point

编号 No.	名称 Name	取值范围 Range of values	默认值 Default value	单位 Unit	适用 Apply
Pn036	原点位置偏移高位 Origin position offset high	-9999~9999	0	万个脉冲 ten thousand pulse	All
Pn037	原点位置偏移低位 Origin position offset low	-9999~9999	0	脉冲	All
找到原点后，加上偏移量 (Pn036*10000+ Pn037) 作实际原点。When the origin is found, the offset (Pn036*10000+, Pn037) is added as the actual origin.					

编号 No.	名称 Name	取值范围 Range of values	默认值 Default value	单位 Unit	适用 Apply
Pn038	原点回归第一速度 Origin regression first speed	1~3000	200	R/min	All
Pn039	原点回归第二速度 Origin regression second speed	1~3000	50	R/min	All
执行原点回归操作时，以第一速度寻找参考点，到达参考点后，以第二速度寻找原点。第二速度应小于第一速度。When the origin return operation is performed, the reference point is searched at the first speed, and the original point is searched at the second speed after reaching the reference point. Second the speed should be less than the first speed.					

编号 No.	名称 Name	取值范围 Range of values	默认值 Default value	单位 Unit	适用 Apply
Pn040	原点回归加速时间	5~10000	50	ms	All

	Origin regression acceleration time				
Pn041	原点回归减速时间 Origin regression deceleration time	5~10000	50	ms	All
	原点回归执行中，电机从零速加速至额定速度的时间，仅用于原点回归操作。In origin regression execution, the motor is accelerated from zero to the rated speed and is used only for origin return operations.				

编号 No.	名称 Name	取值范围 Range of values	默认值 Default value	单位 Unit	适用 Apply
Pn042	原点在位延时 Origin on time delay	0~3000	60	ms	All
	到达原点后，延时一段时间，让电机完全静止。延时完成后，输出端口 SigOut 的 HOME 输出变为 ON。After reaching the origin, the motor is completely stationary for a period of time delay. After completion of the delay, the HOME output of the output port SigOut is changed to ON.				

编号 No.	名称 Name	取值范围 Range of values	默认值 Default value	单位 Unit	适用 Apply
Pn043	原点回归完成信号延时 The origin regression completes the signal delay	5~3000	80	ms	All
	HOME 持续的有效时间 HOME sustained effective time				

编号 No.	名称 Name	取值范围 Range of values	默认值 Default value	单位 Unit	适用 Apply
	原点回归指令执行模式 Origin return	0~1	0		All

Pn044	instruction execution mode				
	设置值 Setting value	功能 Function			
	0	原点回归完成后，等待 HOME 信号变成 OFF 再接收和执行指令。 When the origin return is complete, wait for the HOME signal to become OFF, then receive and execute instructions.			
	1	原点回归完成后立刻接收和执行指令。When the origin return is complete, the instruction is received and executed immediately.			

编号 No.	名称 Name	取值范围 Range of values	默认值 Default value	单位 Unit	适用 Apply
Pn045	增益切换选择 Gain switching selection	0~5	0		All
	设置值 Setting value	功能 Function			
	0	固定第 1 增益。Fixed first gain.			
	1	固定第 2 增益。Fixed second gain.			
	2	由输入端口 SigIn 的 Cgain 端子控制，OFF 为第 1 增益，ON 为第 2 增益。Controlled by the Cgain terminal of the input port SigIn, the OFF is first gain and the ON is second gain.			
	3	由速度指令控制，速度指令超过 Pn046 时，切换到第 1 增益。 Controlled by the speed command, when the speed command exceeds Pn046, the switch is switched to first gain			
	4	由脉冲偏差控制，位置偏差超过 Pn046 时，切换到第 1 增益。 When the position deviation exceeds Pn046, the switch is switched to first gain by pulse bias control.			
	5	由电机转速控制，位置偏差超过 Pn046 时，切换到第 1 增益。 Controlled by the motor speed, when the position deviation exceeds Pn046, the switch is switched to first gain.			

	<ul style="list-style-type: none"> 增益切换详见附录 A Gain switching is shown in Appendix A
--	--

编号 No.	名称 Name	取值范围 Range of values	默认值 Default value	单位 Unit	适用 Apply												
Pn046	增益切换水平 Gain switching level	0~30000	80		All												
Pn047	增益切换回差 Gain switching back difference	0~30000	6		All												
<p>根据 Pn045 参数的设置，切换的条件和单位都不相同: Depending on the setting of the Pn045 parameter, the conditions and units for switching are different:</p> <table border="1" style="margin-left: 40px;"> <thead> <tr> <th>Pn045</th> <th>增益切换条件 Gain switching condition</th> <th>单位 Unit</th> </tr> </thead> <tbody> <tr> <td>3</td> <td>速度指令 Speed command</td> <td>r/min</td> </tr> <tr> <td>4</td> <td>脉冲偏差 Pulse deviation</td> <td>个脉冲 Pulse</td> </tr> <tr> <td>5</td> <td>电机转速 motor speed</td> <td>r/min</td> </tr> </tbody> </table>						Pn045	增益切换条件 Gain switching condition	单位 Unit	3	速度指令 Speed command	r/min	4	脉冲偏差 Pulse deviation	个脉冲 Pulse	5	电机转速 motor speed	r/min
Pn045	增益切换条件 Gain switching condition	单位 Unit															
3	速度指令 Speed command	r/min															
4	脉冲偏差 Pulse deviation	个脉冲 Pulse															
5	电机转速 motor speed	r/min															

编号 No.	名称 Name	取值范围 Range of values	默认值 Default value	单位 Unit	适用 Apply
Pn048	增益切换延迟时间 Gain switching delay time	0~20000	20	0.1ms	All
<p>增益切换条件满足到开始切换的延迟时间。如果在延迟阶段检测到切换条件不满足,则取消切换。The gain switching condition satisfies the delay time of the start switch. If the switch condition is detected during the delay phase, the switchover is canceled.</p>					

编号 No.	名称 Name	取值范围 Range of values	默认值 Default value	单位 Unit	适用 Apply
Pn049◆	增益切换时间 1 Gain switching time 1	0~15000	0	0.1ms	All
Pn050◆	增益切换时间 2 Gain switching time 2	0~15000	50	0.1ms	All
增益切换时，当前增益组合在此时间内线性平滑渐变到目标增益组合，组合内的各个参数同时变化。When the gain is switched, the current gain combination is linearly smoothed at this time, gradually varying to the target gain combination, and each parameter in the combination varies simultaneously.					

编号 No.	名称 Name	取值范围 Range of values	默认值 Default value	单位 Unit	适用 Apply
Pn051	电机运行最高速度限定 Maximum speed limit for motor operation	0~5000	3000		All
用于限定电机运行的最高转速。设定值应小于等于额定转速，否则电机可运行的最高转速为额定转速。Used to limit the maximum speed of motor operation. The setting value shall be less than or equal to the rated speed, otherwise the maximum speed at which the motor can run is rated speed.					

编号 No.	名称 Name	取值范围 Range of values	默认值 Default value	单位 Unit	适用 Apply
Pn052▲	SigIn1 端口功能分配 SigIn1 port function allocation	-31~31	1		All
Pn053▲	SigIn 2 端口功能分配 SigIn2 port function allocation	-31~31	2		All
Pn054▲	SigIn 3 端口功能分配 SigIn3 port function allocation	-31~31	19		All
Pn055▲	SigIn 4 端口功能分配 SigIn4 port function allocation	-31~31	8		All
Pn220▲	SigIn5 端口功能分配 SigIn5	-31~31	3		All

	port function allocation																	
Pn221▲	SigIn6 端口功能分配 SigIn6 port function allocation	-31~31	4		All													
Pn222▲	SigIn7 端口功能分配 SigIn7 port function allocation	-31~31	9		All													
Pn223▲	SigIn8 端口功能分配 SigIn8 port function allocation	-31~31	10		All													
Pn224▲	SigIn9 端口功能分配 SigIn9 port function allocation	-31~31	11		All													
Pn225▲	SigIn10 端口功能分配 SigIn10 port function allocation	-31~31	0		All													
<p>• 具体功能分配参照 SigIn 功能详解表。Specific function allocation, refer to SigIn function detailed table.</p> <p>• -1~-31 功能号是 1-31 功能号相应的负逻辑，功能相同，有效电平相反。-1~-31 function number is 1-31 function number, the corresponding negative logic function is the same, the effective level is opposite.</p> <table border="1" style="margin-left: auto; margin-right: auto;"> <thead> <tr> <th>设置值 Setting value</th> <th>SigIn 输入电平 SigIn input level</th> <th>SigIn 对应功能号 SigIn corresponding function number</th> </tr> </thead> <tbody> <tr> <td rowspan="2">正值 Positive</td> <td>低电平 Low level</td> <td>ON</td> </tr> <tr> <td>高电平 High level</td> <td>OFF</td> </tr> <tr> <td rowspan="2">负值 negative</td> <td>低电平 Low level</td> <td>OFF</td> </tr> <tr> <td>高电平 High level</td> <td>ON</td> </tr> </tbody> </table>						设置值 Setting value	SigIn 输入电平 SigIn input level	SigIn 对应功能号 SigIn corresponding function number	正值 Positive	低电平 Low level	ON	高电平 High level	OFF	负值 negative	低电平 Low level	OFF	高电平 High level	ON
设置值 Setting value	SigIn 输入电平 SigIn input level	SigIn 对应功能号 SigIn corresponding function number																
正值 Positive	低电平 Low level	ON																
	高电平 High level	OFF																
负值 negative	低电平 Low level	OFF																
	高电平 High level	ON																

编号 No.	名称 Name	取值范围 Range of values	默认值 Default value	单位 Unit	适用 Apply
Pn056	SigIn 1 端口滤波时间 SigIn1 port filtering time	1~1000	2	ms	All

Pn057	SigIn 2 端口滤波时间 SigIn2 port filtering time	1~1000	2	ms	All
Pn058	SigIn 3 端口滤波时间 SigIn3 port filtering time	1~1000	2	ms	All
Pn059	SigIn 4 端口滤波时间 SigIn4 port filtering time	1~1000	2	ms	All
Pn226	SigIn5 端口滤波时间 SigIn5 port filtering time	1~1000	2	ms	All
Pn227	SigIn6 端口滤波时间 SigIn6 port filtering time	1~1000	2	ms	All
Pn228	SigIn7 端口滤波时间 SigIn7port filtering time	1~1000	2	ms	All
Pn229	SigIn8 端口滤波时间 SigIn8 port filtering time	1~1000	2	ms	All
Pn230	SigIn9 端口滤波时间 SigIn9 port filtering time	1~1000	2	ms	All
Pn231	SigIn10 端口滤波时间 SigIn10 port filtering time	1~1000	2	ms	All
对输入端口 SigIn 进行数字滤波。Perform digital filtering on the input port SigIn.					

编号 No.	名称 Name	取值范围 Range of values	默认值 Default value	单位 Unit	适用 Apply
Pn060▲	SigOut1 端口功能分配 SigOut1 port function allocation	-14~14	2		All
Pn061▲	SigOut 2 端口功能分配 SigOut2 port function allocation	-14~14	1		All
Pn062▲	SigOut 3 端口功能分配 SigOut3 port function allocation	-14~14	4		All
Pn063▲	SigOut 4 端口功能分配 SigOut4 port function allocation	-14~14	7		All
Pn232▲	SigOut 3 端口功能分配 SigOut3 port function allocation	-14~14	9		All
Pn233▲	SigOut 4 端口功能分配 SigOut4	-14~14	10		All

port function allocation					
	参数值 parameter values	对应功能号 Corresponding function number	SigOut 输出结果 SigOut output results		
	正值 Positive	ON	低电平 Low level		
		OFF	高电平 High level		
	负值 negative	OFF	低电平 Low level		
		ON	高电平 High level		
具体功能分配参照 SigOut 功能详解表。Specific function allocation, refer to SigOut function detailed table.					

编号 No.	名称 Name	取值范围 Range of values	默认值 Default value	单位 Unit	适用 Apply
Pn064▲	通信方式 communication mode	0-2	2		All
	设置值 Setting value	功能 Function			
	0	不通信 No communication			
	1	RS-232			
	2	RS-485			
•通信协议详见 第七章 Modbus 通信功能 。The communication protocol is detailed in the seventh chapter Modbus communication function					

编号 No.	名称 Name	取值范围 Range of values	默认值 Default value	单位 Unit	适用 Apply
Pn065	通信站点 Communication station	1-254	1		All
使用 Modbus 通信时，每组驱动器都应预先设置不同的站点号；若重复设定站点号，将导致通信瘫痪。When using Modbus communication, each group of drivers should set different site numbers in advance. If the site number is repeatedly set, the communication will be paralyzed.					

编号 No.	名称 Name	取值范围 Range of values	默认值 Default value	单位 Unit	适用 Apply														
Pn066▲	通信波特率 Communication baud rate	0-5	5		All														
	<table border="1"> <thead> <tr> <th>设置值 Setting value</th> <th>波特率 baud rate</th> </tr> </thead> <tbody> <tr> <td>0</td> <td>4800</td> </tr> <tr> <td>1</td> <td>9600</td> </tr> <tr> <td>2</td> <td>19200</td> </tr> <tr> <td>3</td> <td>38400</td> </tr> <tr> <td>4</td> <td>57600</td> </tr> <tr> <td>5</td> <td>115200</td> </tr> </tbody> </table>					设置值 Setting value	波特率 baud rate	0	4800	1	9600	2	19200	3	38400	4	57600	5	115200
	设置值 Setting value	波特率 baud rate																	
	0	4800																	
	1	9600																	
	2	19200																	
	3	38400																	
	4	57600																	
5	115200																		

编号 No.	名称 Name	取值范围 Range of values	默认值 Default value	单位 Unit	适用 Apply																				
Pn067▲	通信模式设定 Communication mode setting	0-8	8		All																				
	参数值定义如下表，详见第七章 Modbus 通信功能 The parameter values are defined in the following table, as shown in Chapter seventh, Modbus communication function																								
	<table border="1"> <thead> <tr> <th>设定 Set up</th> <th>格式 format</th> </tr> </thead> <tbody> <tr> <td>0</td> <td>7 , N , 2 (Modbus , ASCII)</td> </tr> <tr> <td>1</td> <td>7 , E , 1 (Modbus , ASCII)</td> </tr> <tr> <td>2</td> <td>7 , 0 , 1 (Modbus , ASCII)</td> </tr> <tr> <td>3</td> <td>8 , N , 2 (Modbus , ASCII)</td> </tr> <tr> <td>4</td> <td>8 , E , 1 (Modbus , ASCII)</td> </tr> <tr> <td>5</td> <td>8 , 0 , 1 (Modbus , ASCII)</td> </tr> <tr> <td>6</td> <td>8 , N , 2 (Modbus , RTU)</td> </tr> <tr> <td>7</td> <td>8 , E , 1 (Modbus , RTU)</td> </tr> <tr> <td>8</td> <td>8 , 0 , 1 (Modbus , RTU)</td> </tr> </tbody> </table>					设定 Set up	格式 format	0	7 , N , 2 (Modbus , ASCII)	1	7 , E , 1 (Modbus , ASCII)	2	7 , 0 , 1 (Modbus , ASCII)	3	8 , N , 2 (Modbus , ASCII)	4	8 , E , 1 (Modbus , ASCII)	5	8 , 0 , 1 (Modbus , ASCII)	6	8 , N , 2 (Modbus , RTU)	7	8 , E , 1 (Modbus , RTU)	8	8 , 0 , 1 (Modbus , RTU)
	设定 Set up	格式 format																							
	0	7 , N , 2 (Modbus , ASCII)																							
	1	7 , E , 1 (Modbus , ASCII)																							
	2	7 , 0 , 1 (Modbus , ASCII)																							
	3	8 , N , 2 (Modbus , ASCII)																							
	4	8 , E , 1 (Modbus , ASCII)																							
	5	8 , 0 , 1 (Modbus , ASCII)																							
6	8 , N , 2 (Modbus , RTU)																								
7	8 , E , 1 (Modbus , RTU)																								
8	8 , 0 , 1 (Modbus , RTU)																								

编号 No.	名称 Name	取值范围 Range of values	默认值 Default value	单位 Unit	适用 Apply
Pn068	输入功能控制方式选择寄存器 1 The input function control mode selects the register 1	0~32767	0		All
Pn069	输入功能控制方式选择寄存器 2 The input function control mode selects the register 2	0~32767	0		All

• 确定功能由通信方式或端口输入方式控制。若不进行通信方式控制, 设置 0 即可。Certain functions are controlled by means of communication or port input. If the communication mode is not controlled, 0 can be set.

• Pn068 参数: Pn068 parameter:

位	BIT7	BIT6	BIT5	BIT4	BIT3	BIT2	BIT1	BIT0
功能 Function	ZeroLock	EMG	TCW	TCCW	CWL	CCWL	Alarmrst	Son
默认值 Default value	0	0	0	0	0	0	0	0

BIT15	BIT14	BIT13	BIT12	BIT11	BIT10	BIT9	BIT8
保留 Retain	Cgain	Cmode	TR2	TR1	Sp3	Sp2	Sp1
0	0	0	0	0	0	0	0

• Pn069 参数: Pn069 parameter:

位	BIT7	BIT6	BIT5	BIT4	BIT3	BIT2	BIT1	BIT0
功能 Function	REF	GOH	PC	INH	Pclear	Cinv	Gn2	Gn1
默认值 Default value	0	0	0	0	0	0	0	0

BIT15	BIT14	BIT13	BIT12	BIT11	BIT10	BIT9	BIT8
保留 Retain	Punlock	Pdistance	Psource	pstop	ptriger	Pos2	Pos1
0	0	0	0	0	0	0	0

- 在通信控制时，确定以上功能由 CN2 上的输入端口或由通信控制来改变。设置为 0，则由 CN2 上的输入端口控制改变；设置为 1，则由通信控制改变。默认全由输入端口控制。例如：son sp3 sp2 sp1 功能通过通信方式控制，其它通过输入端口控制，则设置值为 00000111_00000001(二进制) --> 0x0701(十六进制) -->1793(十进制)，所以设置 Pn068 参数的值为 1793。In communication control, the above functions are determined by the input port on the CN2 or by the communication control. Set to 0, the control is changed by the input port on the CN2; set to 1, then changed by the communication control. The default is entirely controlled by the input port. For example: son SP3 SP2 SP1 function through the communication control and other control through the input port, the setting value is 00000111_00000001 (binary) / 0x0701 (sixteen m) -->1793 (decimal), so set the Pn068 parameter to 1793.

编号 No.	名称 Name	取值范围 Range of values	默认值 Default value	单位 Unit	适用 Apply
Pn070	输入功能逻辑状态设置寄存器 3 Input function logic status setting register 3	0~32767	32691		All
Pn071	输入功能逻辑状态设置寄存器 3 Input function logic status setting register 3	0~32767	32767		All

- 在进行 RS232 或 RS485 通信时，并设置了 Pn068, Pn069 相应的位由通信控制，对本参数与之对应的位进行置位或清零，即可控制输入功能信号的状态。逻辑 0 为有效状态。When RS232 or RS485 communication is carried out, Pn068 is set up, and the corresponding bits of Pn069 are controlled by communication, and the position of the corresponding parameter is set or cleared to control the status of the input function signal. Logical 0 is valid.

- Pn070 参数: Pn070 parameter:

位 position	BIT7	BIT6	BIT5	BIT4	BIT3	BIT2	BIT1	BIT0
功能 Function	ZeroLock	EMG	TCW	TCCW	CWL	CCWL	Alarmrst	Son
默认值 Default value	1	0	1	1	0	0	1	1

BIT15	BIT14	BIT13	BIT12	BIT11	BIT10	BIT9	BIT8
保留 Retain	Cgain	Cmode	TR2	TR1	Sp3	Sp2	Sp1

0	1	1	1	1	1	1	1
---	---	---	---	---	---	---	---

• Pn071 参数: Pn071 parameter:

位 Position	BIT7	BIT6	BIT5	BIT4	BIT3	BIT2	BIT1	BIT0
功能信号 Functional signal	REF	GOH	PC	INH	Pclear	Cinv	Gn2	Gn1
默认值 Default value	1	1	1	1	1	1	1	1

BIT15	BIT14	BIT13	BIT12	BIT11	BIT10	BIT9	BIT8
保留 Retain	Punlock	Pdistance	Psource	Pstop	Ptriger	Pos2	Pos1
0	1	1	1	1	1	1	1

• 在通信控制方式下, 通过设置本寄存器的位, 即可达到 CN2 外部输入信号控制的效果。例如: 驱动器在位置控制模式下, 要禁止脉冲指令, 设置 Pn071 的 BIT4 设置 0, 则输入的脉冲变为无效。非通信控制下, 设置本参数值, 一律无效。In the communication control mode, by setting the bits of this register, we can achieve the effect of CN2 external input signal control. For example: the driver in the position control mode, to prohibit the pulse command, set the Pn071 BIT4 settings 0, then the input pulse becomes invalid. Non communication control, set the value of the reference, are invalid.

注意: 每次上电后, 驱动器会自动载入 Pn070, Pn071 寄存器的值, 并马上执行相应的操作。所以, 在使能电机前, 确定输入功能信号进入正确的工作状态。Note: each time the power is on, the drive automatically loads the values of the Pn070, Pn071 registers, and executes the corresponding operations immediately. Therefore, before the enable motor, the input function signal is determined to enter the correct working state.

编号 No.	名称 Name	取值范围 Range of values	默认值 Default value	单位 Unit	适用 Apply
Pn072	输入功能控制方式选择寄存器 3 The input function control mode selects the register 3	0~1	0		All
Pn073	输入功能逻辑状态设置寄存器 3 Input function logic status setting register 3	0~1	1		All

• Pn072 参数: Pn072 parameter:

位 Position	BIT15~BIT1	BIT0
功能 Function	保留 Retain	Sen

默认值 Default value	0	0
-------------------	---	---

• Pn073 参数 Pn073 parameter

位 Position	BIT15~BIT1	BIT0
功能 Function	保留 Retain	Sen
默认值 Default value	0	1

编号 No.	名称 Name	取值范围 Range of values	默认值 Default value	单位 Unit	适用 Apply
Pn074	风扇开启温度 Fan opening temperature	30~70	50	°C	All
Pn075	风扇运行方式 Fan operation mode	0~2	0		All

	Pn075	风扇运行方式 Fan operation mode			
	0	感温自动运行 Temperature sensing automatic operation			
	1	开机运行 Boot operation			
	2	关闭 Close			

编号 No.	名称 Name	取值范围 Range of values	默认值 Default value	单位 Unit	适用 Apply
	紧急停机 (EMG) 复位方式 Emergency shutdown (EMG) reset mode	0-1	0		All

Pn076	<ul style="list-style-type: none"> 解除 EMG 状态 OFF 后，清除 EMG (AL-14) 报警的条件：Clear the EMG (AL-14) alarm condition after the EMG status OFF is lifted: 						
	<table border="1" style="width: 100%;"> <thead> <tr> <th style="width: 30%;">设置值 Setting value</th> <th>功能 Function</th> </tr> </thead> <tbody> <tr> <td style="text-align: center;">0</td> <td>必须在伺服使能 OFF 下，通过手动或端口 SigIn: AlarmRst 清除。The servo must enable the OFF to be cleared by manual or port SigIn:AlarmRst.</td> </tr> <tr> <td style="text-align: center;">1</td> <td>无论伺服使能 ON 或 OFF，EMG 再次变为 ON，会自动清除。No matter the servo enable ON or OFF, the EMG changes to ON again and will be automatically cleared.</td> </tr> </tbody> </table>	设置值 Setting value	功能 Function	0	必须在伺服使能 OFF 下，通过手动或端口 SigIn: AlarmRst 清除。The servo must enable the OFF to be cleared by manual or port SigIn:AlarmRst.	1	无论伺服使能 ON 或 OFF，EMG 再次变为 ON，会自动清除。No matter the servo enable ON or OFF, the EMG changes to ON again and will be automatically cleared.
	设置值 Setting value	功能 Function					
0	必须在伺服使能 OFF 下，通过手动或端口 SigIn: AlarmRst 清除。The servo must enable the OFF to be cleared by manual or port SigIn:AlarmRst.						
1	无论伺服使能 ON 或 OFF，EMG 再次变为 ON，会自动清除。No matter the servo enable ON or OFF, the EMG changes to ON again and will be automatically cleared.						
<ul style="list-style-type: none"> 在使能 ON 的状态下，若外部有指令输入，EMG 报警自动清除后，指令立即被执行。In the enabling ON state, if the external command input, the EMG alarm is automatically cleared, the instructions are executed immediately. 							

编号 No.	名称 Name	取值范围 Range of values	默认值 Default value	单位 Unit	适用 Apply				
Pn077	正/反驱动禁止检出 Positive / reverse drive forbidden detection	0-2	0		All				
	若使用了 ccwl 或 cwl 功能，当 ccwl 或 cwl 为 OFF 状态时，可设置是否发出 AL-15 报警： If you use the ccwl or CWL function, when ccwl or CWL is the OFF state, you can set whether or not to issue a AL-15 alarm:								
<table border="1" style="width: 100%;"> <thead> <tr> <th style="width: 30%;">设置值 Setting value</th> <th>功能 function</th> </tr> </thead> <tbody> <tr> <td style="height: 40px;"></td> <td></td> </tr> </tbody> </table>		设置值 Setting value	功能 function						
设置值 Setting value	功能 function								

	0	不发出报警, 减速停止。Do not alarm, slow down and stop.
	1	电机运行时, 减速停止后, 发出报警, 电机不再通电。When the motor is running, when the deceleration is stopped, the alarm is sent out, and the motor is no longer energized.
	2	立刻发出报警, 电机断电, 自由停机。Alarm immediately, motor power off, free stop.

编号 No.	名称 Name	取值范围 Range of values	默认值 Default value	单位 Unit	适用 Apply						
Pn078	电压不足检出 Undervoltage detection	0~1	1		All						
	<table border="1"> <thead> <tr> <th>设置值 Setting value</th> <th>功能 Function</th> </tr> </thead> <tbody> <tr> <td>0</td> <td>不检出 Not detected</td> </tr> <tr> <td>1</td> <td>检出 detection</td> </tr> </tbody> </table>					设置值 Setting value	功能 Function	0	不检出 Not detected	1	检出 detection
	设置值 Setting value	功能 Function									
	0	不检出 Not detected									
1	检出 detection										

编号 No.	名称 Name	取值范围 Range of values	默认值 Default value	单位 Unit	适用 Apply
Pn079	系统状态显示项目选择 System status display project selection	0-30	0		All
	<p>驱动器上电后, 自动进入监视模式菜单Dn000子菜单。默认情况下, 按厂家的方式显示系统状态(电机转速), 用户可以设置本参数值, 使Dn000显示特定的系统状态参数, 具体说明参见“监控模式一览表”。After the drive is powered on, automatically enter the monitor mode menu Dn000 submenu. By default, the state display system according to the manufacturer the way (motor speed), the user can set the parameter values, the Dn000 display system state specific parameters, specifically refer to "monitor model list".</p> <p>0 系统默认(电机运行速度) 0 system defaults (motor speed) 1 速度指令 1 speed command 2 平均转矩 2 average torque 3 位置偏差量 3 position deviation 4 交流电源电压 4 AC power supply voltage 5 最大瞬时力矩 5 maximum instantaneous</p>				

	<p>torque 6 脉冲输入频率 6 pulse input frequency 7 散热片温度 7 heat sink temperature 8 当前电机运行速度 8 current motor speed</p> <p>9 有效输入指令脉冲累计值低位 9 the effective input command pulse accumulated value is low</p> <p>10 有效输入指令脉冲累计值高位 10 the effective input command pulse accumulation value is high</p> <p>11 位置控制时, 编码器有效反馈脉冲累计值低位 11 position control, the encoder effective feedback pulse accumulated value is low</p> <p>12 位置控制时, 编码器有效反馈脉冲累计值高位 12 position control, the encoder effective feedback pulse accumulation value is high</p> <p>13 再生制动负载率 13 regenerative braking load rate</p> <p>14 输入端口信号状态 14 input port signal status 15 输出端口信号状态 15 output port signal status</p> <p>16 模拟转矩指令电压 16 analog torque command voltage 17 模拟速度指令电压 17 analog speed command voltage</p> <p>18 输出功能状态寄存器 18 output function status register</p> <p>19 伺服上电后, 编码器反馈脉冲累计值低位 19 after servo power on, the encoder feedback pulse accumulated value is low</p> <p>20 伺服上电后, 编码器反馈脉冲累计值高位 20 After 20 servo power on, the encoder feedback pulse accumulation value is high</p> <p>21 驱动器软件版本 21 drive software version 22 编码器UVW信 22 encoder UVW letter 23 转子绝对位置 23 rotor absolute position 24 驱动器型号 24 drive type</p> <p>25 绝对器编码器单圈数据低位 25 absolute encoder single loop low data 26 绝对器编码器单圈数据高位 26 absolute encoder single loop data high</p> <p>27 绝对器编码器多圈数据低位 27 absolute encoder multi ring data low 28 绝对器编码器多圈数据高位 28 absolute encoder multi ring data high</p> <p>30 负载惯量比显示 30 load inertia ratio display</p>
--	--

编号 No.	名称 Name	取值范围 Range of values	默认值 Default value	单位 Unit	适用 Apply
	增量式编码器线数 Incremental encoder line number	0~16000	0	线 line	All
	• 安装在电机轴上的编码器线数。设置值必须与编码器规定的线数标称值完全一样,				

Pn080	<p>编码器安装的电机角度及接线符合驱动器的接线定义，否则出现电机卡死、跑飞或执行位置指令出现偏差等非正常现象。一般用户不需修改本参数，默认值即可。若编码器为绝对式编码器，本参数设置无效。The number of encoders mounted on the motor shaft. Setting values must be specified with the encoder line number nominal values are exactly the same, the motor angle encoder installation and wiring connection with defined drive, otherwise blocking of the motor run or position deviation and other non normal instruction execution. General users do not need to modify this parameter, the default value can be. If the encoder is absolute encoder, this parameter setting is invalid.</p> <p>• 取0值时，为电机标配编码器的线数值。When 0 values are taken, it is the line value of the motor standard encoder.</p>
-------	---

编号 No.	名称 Name	取值范围 Range of values	默认值 Default value	单位 Unit	适用 Apply
Pn081	用户参数永久写入操作 User parameter permanent write operation	0-1	0		All
	<p>对应辅助模式 Fn001 操作。将当前 Pn000~Pn219 的所有参数值写入到 EEPROM 中。当参数值由 0 变为 1，驱动器就会执行一次写操作。此操作只在通信时有效 (Pn064>0)。 Corresponding auxiliary mode Fn001 operation. Writes all parameter values of the current Pn000~Pn219 to EEPROM. When the parameter value is changed from 0 to 1, the driver will execute a write operation. This operation is only valid when communicating (Pn064>0).</p>				

编号 No.	名称 Name	取值范围 Range of values	默认值 Default value	单位 Unit	适用 Apply
Pn082	SigOut 端口强制输出 SigOut port forced output	0~4095	0		All

- 强制 SigOut 端口输出固定电平。通过设置本参数，强制输出端口的电平状态。Force the SigOut port to output the fixed level. By setting this parameter, the output level of the output port is forced.

	保留 Retain	SigOut5	SigOut4		SigOut3		SigOut2		SigOut1	
位 position	BIT15~BIT10	BIT19~BIT8	BIT7	BIT6	BIT5	BIT4	BIT3	BIT2	BIT1	BIT0
默认值 Default value	0	0	0	0	0	0	0	0	0	0

输出端口真值表如下：The output port truth table is as follows:

SigOut2			SigOut1		
BIT3	BIT2	输出电平 Output level	BIT1	BIT0	输出电平 Output level
0	0	非强制态 Non coercive state	0	0	非强制态 Non coercive state
0	1	强制高电平 Forced high level	0	1	强制高电平 Forced high level
1	0	强制低电平 Forced low level	1	0	强制低电平 Forced low level
1	1	非强制态 Non coercive state	1	1	非强制态 Non coercive state

SigOut4			SigOut3		
BIT7	BIT6	输出电平 Output level	BIT5	BIT4	输出电平 Output level
0	0	非强制态 Non coercive state	0	0	非强制态 Non coercive state
0	1	强制高电平 Forced high level	0	1	强制高电平 Forced high level
1	0	强制低电平 Forced low level	1	0	强制低电平 Forced low level
1	1	非强制态 Non coercive state	1	1	非强制态 Non coercive state

SigOut5		
BIT9	BIT8	输出电平 Output level
0	0	非强制态 Non coercive state
0	1	强制高电平 Forced high level
1	0	强制低电平 Forced low level
1	1	非强制态 Non coercive state

例：输出端口 SigOut2 强制输出低电平，其它端口状态非强制输出，则设置 Pn082 参数值为 8。Example: the output port SigOut2 forces the output to be low, and the other port states are not forced to output. The Pn082 parameter is set to 8.

编号 No.	名称 Name	取值范围 Range of values	默认值 Default value	单位 Unit	适用 Apply
Pn083	低压报警检测幅值 Low voltage alarm detection amplitude	50~280	200	V	All
当母线电压低于此幅值时，由 Pn078 决定是否发出报警。When the bus voltage is below this amplitude, the Pn078 determines whether or not the alarm is given.					

编号 No.	名称 Name	取值范围 Range of values	默认值 Default value	单位 Unit	适用 Apply
Pn084	高温报警检测幅值 High temperature alarm detection amplitude	0~100	70	摄氏 度-	All
当散热片温度高于此幅值时，将发出报警。若设置为 0，则屏蔽报警。When the heat sink temperature is higher than this amplitude, the alarm will be sent out. If set to 0, screen the alarm.					

编号 No.	名称 Name	取值范围 Range of values	默认值 Default value	单位 Unit	适用 Apply								
Pn085▲	电机极对数 Pole count of motor	0~100	0	对 Right	All								
参数为 0 时，为驱动器默认取值。Default value for the drive when the parameter is 0.													
编号 No.	名称 Name	取值范围 Range of values	默认值 Default value	单位 Unit	适用 Apply								
Pn087▲	制动电阻选择 Selection of braking resistance	0~2	1	-	All								
	<table border="1"> <thead> <tr> <th>设置值 Setting value</th> <th>功能 Function</th> </tr> </thead> <tbody> <tr> <td>0</td> <td>未安装制动电阻 No braking resistors are installed</td> </tr> <tr> <td>1</td> <td>使用内置制动电阻 Use built in brake resistors</td> </tr> <tr> <td>2</td> <td>使用外置制动电阻 Use an external braking resistor</td> </tr> </tbody> </table>					设置值 Setting value	功能 Function	0	未安装制动电阻 No braking resistors are installed	1	使用内置制动电阻 Use built in brake resistors	2	使用外置制动电阻 Use an external braking resistor
	设置值 Setting value	功能 Function											
	0	未安装制动电阻 No braking resistors are installed											
1	使用内置制动电阻 Use built in brake resistors												
2	使用外置制动电阻 Use an external braking resistor												

编号 No.	名称 Name	取值范围 Range of values	默认值 Default value	单位 Unit	适用 Apply
Pn088	制动电阻再生过载报警水平 Brake resistor regeneration overload alarm level	50~250	90	%	All
	<ul style="list-style-type: none"> 制动电阻再生过载率越高，电阻表面温度越高。The higher the overload rate of the resistor regeneration, the higher the resistance surface temperature. 当内置或外置制动电阻再生制动负载率低于报警水平时，不进行过载报警。When the internal or external braking resistor, the regenerative braking load rate is lower than the alarm level, the overload alarm is not carried out. 设置 Pn092=0, 蔽再生过载报警。Set Pn092=0, shield regeneration overload alarm. 				

编号 No.	名称 Name	取值范围 Range of values	默认值 Default value	单位 Unit	适用 Apply
Pn089▲	外置制动电阻功率 External braking resistance power	20~20000	100	W	All
Pn090▲	外置制动电阻阻值 External braking resistance value	10~1000	100	Ω	All
Pn091	外置制动电阻再生可用容量 External brake resistance, regeneration, available capacity	5~75	20	%	All
<ul style="list-style-type: none"> 当使用外置制动电阻 (Pn087=2) 时，必须设置标称的电阻功率值和阻值。When using an external braking resistor (Pn087=2), a nominal resistance, power value, and resistance must be set. 设置制动电阻可用容量时，须考虑环境温度、通风强度及电阻散热特性等散热因素，应降额使用电阻。制动电阻可用容量不宜过高，否则电阻表面温升可达几百摄氏度，烧毁电阻，引发火灾。请在安全条件选配制动电阻。当制动电阻安装在大片散热器上时，若进行自然冷却，可尝试设置 25%，若进行强风对吹，可尝试设置 45%。系统动作一段时间后，检查电阻温度是否过高。尝试多次后，仍出现再生过载报警，而电阻温度处于容许范围内，可设置 Pn092=0，即禁止制动电阻相关报警。When the available capacity of the brake resistance is set, heat dissipation factors such as ambient temperature, ventilation intensity and resistance, heat dissipation characteristics must be taken into account, and the resistance shall be decreased. Braking resistor 					

	<p>available capacity should not be too high, otherwise the resistance surface temperature up to several hundred degrees Celsius, burning resistance, causing fire. Please choose the brake resistor in safe condition. When the brake resistance is mounted on a large radiator, if it is naturally cooled, try to set 25%. If a strong wind blows, try setting 45%. After checking the system for a period of time, check whether the resistance temperature is too high. After repeated attempts, the regenerative overload alarm still occurs, while the resistance temperature is within the allowable range, and the Pn092=0 can be set, that is to say, no braking resistance is concerned.</p>
--	--

编号 No.	名称 Name	取值范围 Range of values	默认值 Default value	单位 Unit	适用 Apply
Pn092	制动电阻过载检出 Overload detection of braking resistor	0~1	1	-	All
	设置值 Setting value	功能 function			
	0	再生过载时，不发出报警 Do not issue alarm when regenerative overload occurs			
	1	再生过载时，发出报警 Issue alarm when regenerative overload occurs			

4.3.2 位置控制参数 Position control parameter

编号 No.	名称 Name	取值范围 Range of values	默认值 Default value	单位 Unit	适用 Apply
	指令脉冲输入方式 Command pulse input mode	0-2	0		P

Pn096▲	Pn096		正命令 Direct order	负命令 Negative command
	0	脉冲+方向 Pulse + direction		
	1	正转 / 反转脉冲 Forward / reverse pulse		
	2	正交脉冲 Quadrature pulse		

4

编号 No.	名称 Name	取值范围 Range of values	默认值 Default value	单位 Unit	适用 Apply
Pn097▲	指令脉冲输入方向逻辑选择 Instruction pulse input direction logic selection	0-1	0		P
	设置值 Setting value	功能 Function			
	0	输入正命令，电机逆时针(ccw)旋转 Enter the positive command and turn the motor counter clockwise (CCW)			
	1	输入正命令，电机顺时针(cw)旋转 Enter the positive command and turn the motor clockwise (CW)			

编号 No.	名称 Name	取值范围 Range of values	默认值 Default value	单位 Unit	适用 Apply
Pn098	脉冲电子齿轮比之分子 1Pulse	1~32767	1		P

	electron gear ratio of molecule 1																			
Pn099	脉冲电子齿轮比之分子 2Pulse electron gear ratio of molecule 2	1~32767	1		P															
Pn100	脉冲电子齿轮比之分子 3Pulse electron gear ratio of molecule 3	1~32767	1		P															
Pn101	脉冲电子齿轮比之分子 4Pulse electron gear ratio of molecule 4	1~32767	1		P															
Pn102 ▲	脉冲电子齿轮比之分母 The denominator of a pulsed electronic gear ratio	1~32767	1		P															
	<p>电子齿轮比之分子 N 由输入端口 SigIn 的 GN1, GN2 决定。分母固定。分子选择如下表: The molecular N of the electronic gear ratio is determined by GN1, GN2 of the input port SigIn. Denominator fixing. Molecular selection follows:</p> <table border="1" style="margin-left: 40px;"> <thead> <tr> <th>GN2</th> <th>GN1</th> <th>电子齿轮比分子 N Electronic gear ratio, molecular N</th> </tr> </thead> <tbody> <tr> <td>OFF</td> <td>OFF</td> <td>分子 1 Molecule 1</td> </tr> <tr> <td>OFF</td> <td>ON</td> <td>分子 2 Molecule 2</td> </tr> <tr> <td>ON</td> <td>OFF</td> <td>分子 3 Molecule 3</td> </tr> <tr> <td>ON</td> <td>ON</td> <td>分子 4 Molecule 4</td> </tr> </tbody> </table>					GN2	GN1	电子齿轮比分子 N Electronic gear ratio, molecular N	OFF	OFF	分子 1 Molecule 1	OFF	ON	分子 2 Molecule 2	ON	OFF	分子 3 Molecule 3	ON	ON	分子 4 Molecule 4
GN2	GN1	电子齿轮比分子 N Electronic gear ratio, molecular N																		
OFF	OFF	分子 1 Molecule 1																		
OFF	ON	分子 2 Molecule 2																		
ON	OFF	分子 3 Molecule 3																		
ON	ON	分子 4 Molecule 4																		

编号 No.	名称 Name	取值范围 Range of values	默认值 Default value	单位 Unit	适用 Apply
Pn103	位置偏差超出范围设定 The position deviation is out of range setting	1~2000	500	万个脉冲 ten thousand pulse	P
	<p>当脉冲偏差计数器的脉冲数超过所设定的值时(即:当前位置与目标位置相差过大),驱动器就发出报警信号。When the pulse number of the pulse deviation counter exceeds the set value (i.e., the difference between the current position and the target position), the driver sends out an alarm signal.</p>				

编号	名称 Name	取值范围	默认值	单位 Unit	适用
----	---------	------	-----	---------	----

No.		Range of values	Default value		Apply
Pn104	位置定位完成范围设定 Location positioning complete range setting	0~ 32767	10	脉冲 pulse	P
Pn105	位置定位完成回差设定 Location positioning complete backlash setting	0~ 32767	3	脉冲 pulse	P
<p>当偏差计数器的剩余脉冲数低于本参数设定值时, 输出端口 SigOut::Preach 信号就 ON, 否则 OFF。When the residual pulse number of the offset counter is lower than the parameter setting value, the output port SigOut:: Preach signal is ON, otherwise OFF.</p>					

编号 No.	名称 Name	取值范围 Range of values	默认值 Default value	单位 Unit	适用 Apply
Pn106	位置定位接近范围设定 Location positioning complete range setting	0~ 32767	300	脉冲 pulse	P
Pn107	位置定位完成回差设定 Location positioning complete backlash setting	0~ 32767	30	脉冲 pulse	P
<p>当偏差计数器的剩余脉冲数低于本参数设定值时, 输出端口 SigOut 的 Pnear 信号就 ON, 否则 OFF。When the residual pulse number of the offset counter is lower than the parameter setting value, the Pnear signal of the output port SigOut is ON, otherwise OFF.</p>					

编号 No.	名称 Name	取值范围 Range of values	默认值 Default value	单位 Unit	适用 Apply
	位置偏差清除方式 Position deviation clearing mode	0-1	1		P
<p>位置控制时, 可使用 SigIn 的 Pclear 功能, 清除位置偏差计数器的值。位置偏差清除发生在: Position control, you can use the SigIn's Pclear function to clear the</p>					

Pn108	value of the position offset counter. Positional error clearing occurs at:	
	设置值 Setting value	功能 Function
	0	Pclear 电平 ON 期间 Pclear Level ON period
1	Pclear 上升沿时刻(由 OFF 到 ON) Pclear Rising edge time (from OFF to ON)	

编号 No.	名称 Name	取值范围 Range of values	默认值 Default value	单位 Unit	适用 Apply
Pn109◆	位置指令加减速方式 Position command acceleration and deceleration mode	0-2	0		P
	设置值 Setting value	功能 Function			
	0	不使用滤波 No filtering			
	1	一次平滑滤波 One time smooth filtering			
	2	S 形滤波 S shape filtering			

编号 No.	名称 Name	取值范围 Range of values	默认值 Default value	单位 Unit	适用 Apply
Pn110◆	位置指令一次滤波时间常数 Position instruction, primary filtering, time constant	5~500	50	ms	P
Pn111◆	位置指令 S 形滤波时间常数 Ta Position instruction, S shape filtering, time constant Ta	5~340	50	ms	P
Pn112◆	位置指令 S 形滤波时间常数 Ts Position instruction, S shape filtering, time constant Ts	5~150	20	ms	P
	• 滤波时间常数定义：由当前位置指令频率运行到目标指令频率的时间。滤波时间越长，				

位置指令的频率平滑性越好，但指令响应延迟越大。在指令脉冲频率阶跃性变化的场合，起到平滑运行电机的作用。滤波对指令脉冲个数没有影响。Filter time constant definition: the time from the current position, the instruction frequency, to the target instruction frequency. The longer the filtering time, the better the frequency smoothness of the position instruction, but the greater the instruction response delay. On the occasions of step change of the instruction pulse frequency, the motor is operated smoothly. Filtering has no influence on the number of instruction pulses.

- 滤波时间 $T=T_a+T_s$ 。 T_a : 直线部分时间, T_a 越小, 加减速越快。 T_s : 弧线部分时间, T_s 越大, 速度越平滑, 冲击越小。 Filter time $T=T_a+T_s$. T_a : straight part of time, the smaller the T_a , the faster the acceleration and deceleration. T_s : arc part time, the greater the T_s , the smoother the speed, the smaller the impact.

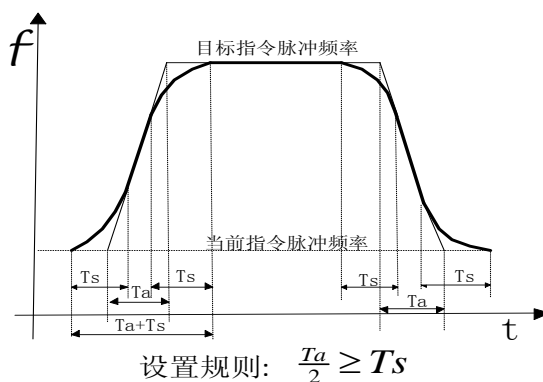

编号 No.	名称 Name	取值范围 Range of values	默认值 Default value	单位 Unit	适用 Apply
Pn113	位置环前馈增益 Position loop feedforward gain	0-100	0	%	P
Pn114▲	位置环前馈过滤器时间常数 Position loop, feedforward filter, time constant	1-50	5	ms	P
位置控制时，位置前馈直接加于速度指令上，可以减小位置的跟踪误差，提高应答。如 果前馈增益过大，可能导致速度过冲。可对前馈命令进行平滑处理。 In position control,					

	the position feedforward is directly applied to the speed command, which can reduce the tracking error of position and improve the response. If the feed forward gain is too large, it may cause velocity overshoot. The feedforward commands can be smoothed.
--	--

编号 No.	名称 Name	取值范围 Range of values	默认值 Default value	单位 Unit	适用 Apply
Pn115	位置调节器增益 1 Position regulator gain 1	1-2000	100	1/S	P
Pn116	位置调节器增益 2 Position regulator gain 2	1-2000	100	1/S	P
	在机械系统不产生振动或是噪音的前提下, 增加位置环增益值, 以加快反应速度, 缩短定位时间。On the premise that the mechanical system does not produce vibration or noise, the position loop gain is increased to accelerate the reaction speed and shorten the positioning time.				

编号 No.	名称 Name	取值范围 Range of values	默认值 Default value	单位 Unit	适用 Apply
Pn117	位置指令源选择 Location command source selection	0~3	0		P
	设置值 Setting value	功能 Function			
	0	外部脉冲输入 External pulse input			
	1	内部位置指令 (详见附录 G) Internal position instructions (see Appendix G)			
	2	由 SigIn: psource 确定指令源。On: 内部位置指令; Off: 外部脉冲输入 The command source is determined by the SigIn:psource. On: internal position instruction; Off: external pulse input			
3	运动控制器指令 Motion controller instruction				

编号 No.	名称 Name	取值范围 Range	默认值 Default	单位	适用
--------	---------	------------	-------------	----	----

		of values	value	Unit	Apply
Pn118	内部位置指令暂停方式选择 Internal position instruction pause mode selection	0~1	0		P
	设置值 Setting value	功能 Function			
	0	当 pstop 触发动作后, ptriger 再次触发时, 驱动器根据当前选择的内部位置指令运行。When the pstop trigger action is triggered again, the ptriger is driven according to the currently selected internal location command.			
1	当 pstop 触发动作后, ptriger 再次触发时, 驱动器继续完成上次剩余的内部位置指令脉冲数。When the pstop trigger action is triggered again, the ptriger continues to complete the last remaining internal position command pulses.				

编号 No.	名称 Name	取值范围 Range of values	默认值 Default value	单位 Unit	适用 Apply
Pn119	内部位置暂停减速时间 Internal position suspension deceleration time	0~10000	50	ms	P
在内部位置控制时, pstop 下降沿出现后, 电机由当前运行速度将减速至 0, 其减速时间可由本参数设置 (仅用于内部位置控制)。In the internal position control, when the falling edge of the pstop occurs, the motor will decelerate from the current running speed to 0, and its deceleration time can be set by this parameter (for internal position control only).					

编号 No.	名称 Name	取值范围 Range of values	默认值 Default value	单位 Unit	适用 Apply
Pn120	内部位置指令 0 脉冲数高位设定 Internal position command 0 pulse number high setting	-9999~9999	0	万个脉 冲 Tens of thousan ds	P

				pulse	
Pn121	内部位置指令0脉冲数低位设定 Internal position command 0 pulse number low setting	-9999~9999	0	个	P
Pn122	内部位置指令1脉冲数高位设定 Internal position command 1 pulse number high setting	-9999~9999	0	万个脉 冲 Tens of thousan ds pulse	P
Pn123	内部位置指令1脉冲数低位设定 Internal position command 1 pulse number low setting	-9999~9999	0	个	P
Pn124	内部位置指令2脉冲数高位设定 Internal position command 2 pulse number high setting	-9999~9999	0	万个脉 冲 Tens of thousan ds pulse	P
Pn125	内部位置指令2脉冲数低位设定 Internal position command 2 pulse number low setting	-9999~9999	0	个	P
Pn126	内部位置指令3脉冲数高位设定 Internal position command 3 pulse number high setting	-9999~9999	0	万个脉 冲 Tens of thousan ds pulse	P
Pn127	内部位置指令3脉冲数低位设定 Internal position command 3 pulse number low setting	-9999~9999	0	个	P
	内部位置指令 N (脉冲量) = 内部位置指令 N 脉冲数高位设定值 × 10000 + 内部位置 指令 N 脉冲数低位设定值 Internal position instruction N (Mai Chongliang) = internal position command, N pulse number, high setting value * 10000 + internal				

	<p>position command, N pulse number, low setting value</p> <p>例: 编码器 2500 线, 要走行程 12.5 转, 则设置 Pn120=12, Pn121=5000. Example: encoder 2500 lines, to travel, 12.5 turn, then set Pn120=12, Pn121=5000.</p>
--	---

编号 No.	名称 Name	取值范围 Range of values	默认值 Default value	单位 Unit	适用 Apply
Pn128	内部位置指令 0 运行速度 Internal position instruction 0 running speed	0~3000	100	r/min	P
Pn129	内部位置指令 1 运行速度 Internal position instruction 1 running speed	0~3000	100	r/min	
Pn130	内部位置指令 2 运行速度 Internal position instruction 2 running speed	0~3000	100	r/min	P
Pn131	内部位置指令 3 运行速度 Internal position instruction 3 running speed	0~3000	100	r/min	P
	在执行内部位置指令 N 时, 限定电机能运行的最高速度。When the internal position instruction N is executed, the maximum speed at which the motor can run is defined.				

编号 No.	名称 Name	取值范围 Range of values	默认值 Default value	单位 Unit	适用 Apply
Pn132	转矩/速度控制切换至位置 控制的方式 Torque / speed control switching to position control	0~1	0		P

	在双模式控制时，控制模式从转矩或速度模式转换至位置控制(Pn002=3 或 4)时，为避免发生剧烈的机械冲击，应在较低的速度时进行切换。可设置切换的条件：In dual mode control, when the control mode is switched from torque or speed mode to position control (Pn002=3 or 4), to avoid severe mechanical shock, the switch should be switched at a lower speed. Set the condition for switching:	
	设置值 Setting value	功能 Function
	0	零速度 (zerospeed)
	1	减速至零 Decelerate to zero

编号 No.	名称 Name	取值范围 Range of values	默认值 Default value	单位 Unit	适用 Apply
Pn133	转矩/速度控制切换至位置控制的 减速时间 Torque / speed control switching to position control deceleration time	5-10000	100	ms	P
Pn132=1 时，当 cmode 信号有效，指示控制模式由转矩或速度控制切换至位置控制，电机先减速至零，再切换至位置控制模式。具体时序详见附录 B。Pn132=1, when the Cmode signal is valid, indicating that the control mode is switched from torque or speed control to position control, the motor is decelerated to zero first and then switched to position control mode. See the appendix B for specific timing.					

编号 No.	名称 Name	取值范围 Range of values	默认值 Default value	单位 Unit	适用 Apply
Pn134	定长位移方向 Fixed length displacement direction	0~1	0		P
定长移动时，当 SigIn:Pdistance 触发有效前，需确定电机旋转的方向：When the fixed length is moved, the direction of the motor rotation must be determined before the SigIn:Pdistance is triggered: <ul style="list-style-type: none"> • 0 : 根据当前电机运行速度判断定长位移旋转的方向。当前速度≥ 0，定长位移正转 (CCW)；当前速度< 0，定长位移反转 (CW)。0: according to the current motor speed to determine the fixed length, displacement, rotation direction. The current rate is more than 0, fixed length displacement forward (CCW) ; 					

	<p>the speed of <0, the fixed length displacement inversion (CW).</p> <p>• 1 :根据当前电机运行速度判断定长位移旋转的方向。当前速度>0, 定长位移正转 (CCW); 当前速度≤0, 定长位移反转 (CW)。1: according to the current motor speed to determine the fixed length, displacement, rotation direction. The speed of >0, the fixed length displacement forward (CCW); the current rate is less than 0, fixed length displacement inversion (CW).</p>
--	--

编号 No.	名称 Name	取值范围 Range of values	默认值 Default value	单位 Unit	适用 Apply
Pn135	定长位移高位 Fixed length shift height	0~9999	0	万个	P
Pn136	定长位移低位 Fixed length shift low	0~9999	100	个	P
	当 SigIn:Pdistance 触发有效后, 电机轴将旋转的距离: Pn135*10000+Pn136 (个脉冲)。电机移动方向由 Pn134 确定。When the SigIn:Pdistance is triggered, the motor shaft will rotate at a distance of Pn135*10000+Pn136 (pulse). The moving direction of the motor is determined by Pn134.				

编号 No.	名称 Name	取值范围 Range of values	默认值 Default value	单位 Unit	适用 Apply
Pn137	定长最高运行速度 Maximum running speed at fixed length	10~5000	200	r/min	P
	在执行定长过程中, 电机允许运行的最高速度。The maximum speed at which the motor is allowed to run during a fixed length.				

编号 No.	名称 Name	取值范围 Range of values	默认值 Default value	单位 Unit	适用 Apply
Pn138	定长锁定解除方式 Fixed length locking release	0~1	1		P
	定长位移执行完毕后, 电机处于定长锁定状态, 为正常响应位置指令, 有两种解除方式: After the fixed length shift is completed, the motor is in a fixed length				

	<p>locking state, and is the normal response position instruction. There are two ways of releasing the motor:</p> <ul style="list-style-type: none"> • 0: 无需锁定解除信号, 完成定长位移后, 立即响应位置指令。0: no need to lock the signal, after the completion of fixed displacement, immediate response to position instructions. • 1: 须等待输入端口信号 SigIn:Punlock 信号有效后, 才能响应位置指令。1: must wait for the input port signal, the SigIn:Punlock signal is effective, only then can respond the position instruction.
--	---

编号 No.	名称 Name	取值范围 Range of values	默认值 Default value	单位 Unit	适用 Apply
Pn139	停止时振动抑制衰减比 Vibration suppression ratio at stop	10~100	100	%	P
Pn140	停止时振动抑制等待时间 The wait time is suppressed when the vibration is stopped	0~30000	300	ms	P
Pn141	停止时振动抑制条件 Vibration suppression conditions at stop	0~10000	10	脉冲	P

伺服增益提高到相当程度后, 虽然移动时不发生振动, 但停止后可能会发生振动。本功能仅在停止时作用, 通过降低伺服增益来抑制振动。The servo gain increases to a considerable extent, although vibration does not occur when moving, but vibration may occur after the stop. This function works only at stop time and suppresses vibration by reducing servo gain.

Residual impulse

Servo gain

	<p>从位置指令发送停止时开始, 当剩余脉冲量低于Pn141设定值时, 等待Pn140设定时间后, 衰减内部伺服增益。请在抑制衰减比为50% 以上, 若设定低值, 也可能导致响应性降低, 发生振动。Starting from the position command is stopped, when the impulse is lower than that of the Pn141 mountains left the set value, waiting for Pn140 time, internal servo gain attenuation. If the attenuation ratio is above 50%, if the low value is set, the vibration may also be reduced and vibration will occur.</p>
--	---

4.3.3 速度控制参数 Speed control parameter

编号 No.	名称 Name	取值范围 Range of values	默认值 Default value	单位 Unit	适用 Apply								
Pn146◆	速度指令加减速方式 Speed command plus deceleration mode	0~2	1		S								
	<table border="1"> <thead> <tr> <th>设置值 Setting value</th> <th>功能 Function</th> </tr> </thead> <tbody> <tr> <td>0</td> <td>无加减速 NO Acceleration and deceleration</td> </tr> <tr> <td>1</td> <td>S 曲线加减速 S curve acceleration and deceleration</td> </tr> <tr> <td>2</td> <td>直线加减速 Linear acceleration and deceleration</td> </tr> </tbody> </table>		设置值 Setting value	功能 Function	0	无加减速 NO Acceleration and deceleration	1	S 曲线加减速 S curve acceleration and deceleration	2	直线加减速 Linear acceleration and deceleration			
	设置值 Setting value	功能 Function											
	0	无加减速 NO Acceleration and deceleration											
	1	S 曲线加减速 S curve acceleration and deceleration											
2	直线加减速 Linear acceleration and deceleration												
在速度控制模式并有外部位置环时, 此参数应设置为 0。This parameter should be set to 0 in the speed control mode with an external position loop.													

编号 No.	名称 Name	取值范围 Range of values	默认值 Default value	单位 Unit	适用 Apply
Pn147◆	速度指令 S 曲线加减速时间常数 Ts Speed command, S curve, acceleration and deceleration time constant Ts	5~ 1500	80	ms	S
Pn148◆	速度指令 S 曲线加速时间常数 Ta Speed command, S curve, acceleration time constant, Ta	5~ 10000	80	ms	S
Pn149◆	速度指令 S 曲线减速时间常数 Td Speed command, S curve,	5~ 10000	80	ms	S

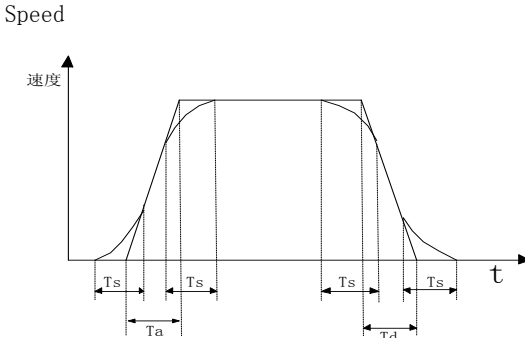
	deceleration time constant Td			
	<p>• 在速度控制方式时，可以设置速度指令的加减速时间，以平滑地对伺服电机进行启动和停止。In the speed control mode, the acceleration and deceleration time of the speed command can be set to smoothly start and stop the servo motor.</p> <p>• Ta: 加速时间: 由 0r/min 起达到额定速度的时间。例如，伺服电机额定转速 3000r/min, 若设置时间 3S, 则由 0r/min 加速至 1000r/min 的时间为 1S. Ta: acceleration time: time from 0r/min to rated speed. For example, the servo motor rated speed 3000r/min, if the set time is 3S, then the speed from 0r/min to 1000r/min is 1S.</p> <p>Td: 减速时间: 由额定速度减至 0r/min 的时间 Td: deceleration time: reduced from rated speed to 0r/min time</p> <p>Ts: 弧线部分的时间 Ts: arc part time</p> <div style="text-align: center;">  <p>Speed 速度</p> <p>设置规则: $\frac{Ta}{2} \geq Ts, \frac{Td}{2} \geq Ts$</p> <p>Set rules</p> </div>			

编号 No.	名称 Name	取值范围 Range of values	默认值 Default value	单位 Unit	适用 Apply
Pn150◆	直线加速时间常数 Linear acceleration time constant	5~30000	80	ms	S
Pn151◆	直线减速时间常数 Linear deceleration time constant	5~30000	80	ms	S
	加速时间常数定义为速度指令从零上升到额定转速的时间。The acceleration time constant is defined as the time that the speed command rises from zero to the rated speed.				

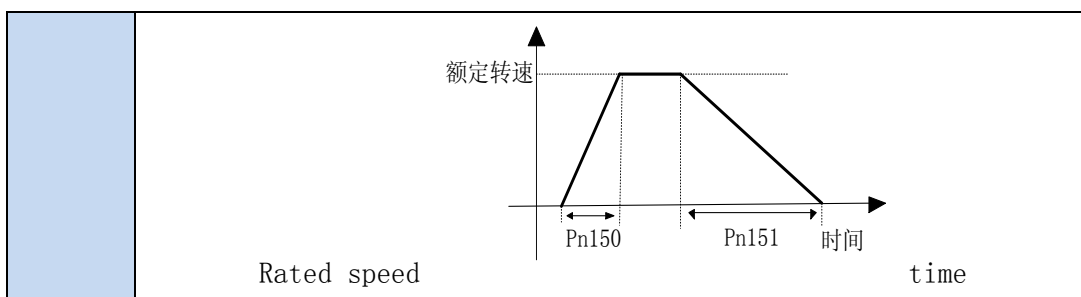

编号 No.	名称 Name	取值范围 Range of values	默认值 Default value	单位 Unit	适用 Apply
Pn152 ▲	速度检测滤波时间常数 Speed detection filter time constant	1~380	1	0.1ms	All
<p>参数值越大，检测到的速度越平滑，但导致速度响应越慢。太大容易导致振荡，太小可能导致噪声。The greater the parameter value, the smoother the speed is detected, but the slower the rate response. Too large to cause oscillations; too small to cause noise.</p>					

编号 No.	名称 Name	取值范围 Range of values	默认值 Default value	单位 Unit	适用 Apply
Pn153	速度调节器比例增益 1 Speed regulator proportional gain 1	1~ 2000	80	Hz	All
Pn154	速度调节器积分时间常数 1 Speed regulator integration time constant 1	1~ 5000	150	0.1ms	All
Pn155	速度调节器比例增益 2 Speed regulator proportional gain 2	1~ 2000	80	Hz	All
Pn156	速度调节器积分时间常数 2 Speed regulator integration time constant 2	1~ 5000	150	0.1ms	All
<p>• 速度环调节器增益直接决定速度控制回路的响应频宽，在机械系统不产生振动或噪音的前提下，增大速度回路增益值，则速度响应加快。The gain of the speed loop controller directly determines the response bandwidth of the speed control loop, and increases the speed loop gain when the mechanical system does not generate vibration or noise, and the speed response is</p>					

	<p>accelerated.</p> <ul style="list-style-type: none"> 积分时间常数用来调整稳态误差的补偿速度，减小参数值，减小速度控制误差，增加刚性。过小容易引起振动和噪声。The integral time constant is used to adjust the compensation speed of steady state error, reduce parameter value, reduce speed control error and increase rigidity. Too small, easy to cause vibration and noise.
--	--

编号 No.	名称 Name	取值范围 Range of values	默认值 Default value	单位 Unit	适用 Apply
Pn157▲	模拟速度指令平滑过滤时间 Simulated speed, instruction smoothing, filtering time	1~500	1	0.1ms	S
	<p>设置值越大，输入模拟量响应速度越慢，有利于减小高频噪声干扰，设置越小，响应速度越快，但干扰噪声会变大。The larger the set value, the slower the input analog response speed is, which is beneficial to reduce the high-frequency noise interference. The smaller the set, the faster the response rate, but the interference noise will become larger.</p>				
编号 No.	名称 Name	取值范围 Range of values	默认值 Default value	单位 Unit	适用 Apply
Pn158	模拟速度指令增益 Analog speed command gain	1~1500	300	r/min /V	S
	<p>模拟量速度指令输入与电机实际运行速度之间的比例关系。电压输入的范围-10~10V。计算公式：速度=输入电压*Pn158。例如：输入电压 10V 时，若设置为 300，相应的速度为 10*300=3000r/min。The proportional relationship between analog speed, command input and actual motor speed. Voltage input range -10~10V. Formula: speed = input voltage *Pn158. For example, when the input voltage is 10V, if it is set to 300, the corresponding speed is 10*300=3000r/min.</p>				

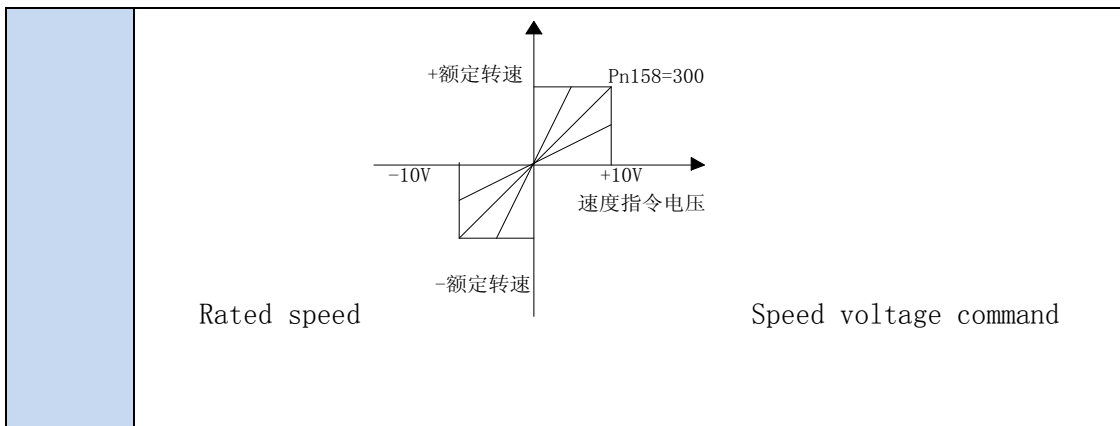

编号 No.	名称 Name	取值范围 Range of values	默认值 Default value	单位 Unit	适用 Apply
Pn159	模拟速度指令偏移调整 Analog speed shift adjustment	-5000~5000	0	mv	S
	<p>• 输入的模拟量可能存在偏移现象，可以通过此参数进行补偿。The analog input may have an offset that can be compensated by this parameter.</p> <p>• 自动调整偏移，可执行 Fn008 操作。Automatically adjust the offset to perform Fn008 operations.</p> <p>• 手动调整偏移步骤如下：Manually adjust the offset step as follows:</p> <ol style="list-style-type: none"> 1: 将外部 0 电位接入模拟输入端口 1: the external 0 potential access analog input port 2: 置本参数为 0, 观察监视模式中 dn17 显示的值。2: set this parameter to 0 and observe the value displayed by the dn17 in the monitor mode. 3: 若观察值不为 0, 输入负的观察值到本参数内, 即可实现调整 (注意电压单位转换关系)。 3: if the observation value is not 0, input negative observation value to this parameter, then can realize the adjustment (pay attention to voltage 				

	unit conversion relation). 例: dn17=1.12V,Pn159 输入-1120mv 即可。Example: dn17=1.12V, Pn159, enter -1120mv.
--	---

编号 No.	名称 Name	取值范围 Range of values	默认值 Default value	单位 Unit	适用 Apply
Pn160	模拟速度指令方向 Analog speed direction	0-1	0		S
	设置值 Setting value	功能 Function			
	0	正电压正转 (ccw), 负电压反转 (cw) Positive voltage forward (CCW), negative voltage reversal (CW)			
	1	负电压正转 (ccw), 正电压反转 (cw) Negative voltage forward (CCW), positive voltage inversion (CW)			

编号 No.	名称 Name	取值范围 Range of values	默认值 Default value	单位 Unit	适用 Apply
Pn161	模拟速度指令强制零区间上限 Analog speed command force zero interval upper limit	0~1000	0	10mv	S
Pn162	模拟速度指令强制零区间下限 Analog speed command forced zero interval lower bound	-1000~0	0	10mv	S
	<p>•输入速度指令位于下限与上限之间时,输入指令强制为 0 V 。When the input speed command is between the lower limit and the upper limit, the input command is forced to 0 V.</p> <div style="text-align: center;"> </div>				

	<ul style="list-style-type: none"> 此时输入电压是经过 PN159 偏移调整后的输入电压。At this point the input voltage is the input voltage adjusted by the PN159 offset. 通过上下限的设置，可使输入指令变为单极性、双极性指令。例：设上限为 0，下限为 -1000，则相当于输入指令范围为 0~10V，为正极性速度指令。Through the setting of the upper and lower limits, the input instructions can be changed into unipolar and bipolar instructions. Example: an upper limit of 0, a lower limit of -1000, equivalent to the input instruction range of 0~10V, for the positive speed command.
--	--

编号 No.	名称 Name	取值范围 Range of values	默认值 Default value	单位 Unit	适用 Apply
Pn163	零速箝位锁定方式 Zero speed clamping lock mode	0-1	0		S
	<ul style="list-style-type: none"> 0: 锁定时，箝位方式是位置环控制时，介入内部的环置环控制，通过 Pn167 设置增益。0: when locking, clamping mode is the position loop control, the intervention of the internal loop control, through the Pn167 set gain. 1: 锁定时，箝位方式是速度环控制，速度指令强制为 0，位置可能因外力作用而发生改变。1: when locking, clamping method is speed loop control, speed command is 0, the position may be changed because of external force. 				

编号 No.	名称 Name	取值范围 Range of values	默认值 Default value	单位 Unit	适用 Apply
Pn164	零速箝位触发方式 Zero speed clamping trigger mode	0~1	0		S
	设置值 Setting value	功能 function			
	0	SigIn 端口 ZeroLock 为 ON SigIn port ZeroLock is ON.			
	1	速度指令低于 Pn165 参数时触发 The speed command is triggered when it is lower than the Pn165 parameter			

编号 No.	名称 Name	取值范围 Range	默认值 Default	单位	适用
--------	---------	------------	-------------	----	----

		of values	value	Unit	Apply
Pn165	零速箝位电平 Zero speed clamping level	0~200	6	r/min	S
	<p>当Pn164设置为1,且速度指令低于本参数值时,对电机轴进行锁定。例:本参数设置为10r/min,如果模拟量速度指令在-10r/min~10r/min范围内时,则进行减速箝位,以防止模拟量速度指令在零附近漂移,导致电机轴不稳定。The motor shaft is locked when the Pn164 is set to 1 and the speed command is lower than the parameter value. Example: this parameter is set to 10r/min. If the analog speed command is in the range of -10r/min~10r/min, the deceleration clamp is used to prevent the analog speed command from drifting near zero, resulting in the instability of the motor shaft.</p>				

编号 No.	名称 Name	取值范围 Range of values	默认值 Default value	单位 Unit	适用 Apply
Pn166	零速箝位减速时间 Zero speed clamping deceleration time	5~10000	50	ms	S
	<p>当零速箝位触发后,立即按减速时间进行减速至零,再进行锁定。After the zero speed clamp is triggered, decelerate immediately to zero at the deceleration time and then lock.</p>				

编号 No.	名称 Name	取值范围 Range of values	默认值 Default value	单位 Unit	适用 Apply
Pn167	内部位置调节器增益 Internal position regulator gain	1-2000	100	1/S	All

编号 No.	名称 Name	取值范围 Range of values	默认值 Default value	单位 Unit	适用 Apply
Pn168	速度指令来源 选择 Speed command source selection	0~2	0		S

	在速度控制模式时, 可选的速度指令来源: Optional optional speed command source in speed control mode:	
	设置值 setting value	功能 Fncion
	0	外部模拟速度指令+内部速度 2~8 External analog speed command + internal speed 2~8
	1	内部速度 1 ~8 Internal speed 1 ~8
	2	运动控制器模拟电压指令 Motion controller analog voltage command

编号 No.	名称 Name	取值范围 Range of values	默认值 Default value	单位 Unit	适用 Apply
Pn169	内部速度指令 1 Internal speed command 1	-5000-5000	0	R/min	S
Pn170	内部速度指令 2 Internal speed command 2	-5000-5000	0	R/min	S
Pn171	内部速度指令 3 Internal speed command 3	-5000-5000	0	R/min	S
Pn172	内部速度指令 4 Internal speed command 4	-5000-5000	0	R/min	S
Pn173	内部速度指令 5 Internal speed command 5	-5000-5000	0	R/min	S
Pn174	内部速度指令 6 Internal speed command 6	-5000-5000	0	R/min	S
Pn175	内部速度指令 7 Internal speed command 7	-5000-5000	0	R/min	S
Pn176	内部速度指令 8 Internal speed command 8	-5000-5000	0	R/min	S

当驱动器的控制模式处于速度控制模式时，速度指令来源由输入端口 SigIn 的 SP1, SP2, SP3 决定：When the drive control mode is in the speed control mode, the source of the speed command is determined by SP1, SP2, SP3 of the input port SigIn:

SP3	SP2	SP1	速度指令 Speed command
0	0	0	内部速度 1/外部模拟速度指令(由 Pn168 决定) Internal speed 1/ external analog speed command (determined by Pn168)
0	0	1	内部速度 2 Internal speed 2
0	1	0	内部速度 3 Internal speed 3
0	1	1	内部速度 4 Internal speed 4
1	0	0	内部速度 5 Internal speed 5
1	0	1	内部速度 6 Internal speed 6
1	1	0	内部速度 7 Internal speed 7
1	1	1	内部速度 8 Internal speed 8

注 1: 0 表示 OFF, 1 表示 ON。 Note 1: 0 indicates OFF, and 1 stands for ON.

注 2: 若 SigIn 端口没有指定 SP3, SP2, SP1 功能，默认都是 OFF 状态。 Note 2: if the SigIn port does not specify SP3, SP2, and SP1 functions, the default is the OFF state.

编号 No.	名称 Name	取值范围 Range of values	默认值 Default value	单位 Unit	适用 Apply
Pn177	JOG 速度 JOG speed	0~5000	200	r/min	S
Pn178◆	JOG 加速时间 JOG Acceleration time	5~ 10000	100	ms	S
Pn179◆	JOG 减速时间 JOG Deceleration time	5~ 10000	100	ms	S
	点动试运行，可设置电机运行的速度与加减速时间。When inching test run, the speed of motor operation and the time of acceleration and deceleration can be set.				

编号 No.	名称 Name	取值范围 Range of values	默认值 Default value	单位 Unit	适用 Apply
--------	---------	----------------------	-------------------	---------	----------

Pn182	速度环 PDFF 控制系数 Speed loop PDFF control factor	0~100	100	-	PS
	本参数决定了速度环的控制结构。Pn182=100 时，为 PI 控制结构；Pn182=0 时，为 I-P 控制。This parameter determines the control structure of the speed loop. Pn182=100, for the PI control structure; Pn182=0, for the I-P control.				

编号 No.	名称 Name	取值范围 Range of values	默认值 Default value	单位 Unit	适用 Apply
Pn183~	速度反馈补偿 Speed feedback compensation	0~100	0	%	PS
	对反馈速度进行补偿，补偿值越大，电机噪声越响。The feedback speed is compensated, and the greater the compensation value is, the more noise the motor will make.				

4.3.4 转矩控制参数 Torque control parameter

编号 No.	名称 Name	取值范围 Range of values	默认值 Default value	单位 Unit	适用 Apply
Pn186	转矩指令加减速方式 Torque command acceleration and deceleration mode	0~1	0		T
	设置值 Setting value	功能 Function			
	0	不使用转矩指令加减速 Do not use torque command to speed up and down			
	1	使用转矩指令直线加减速 Using torque command, linear acceleration and deceleration			

编号 No.	名称 Name	取值范围 Range of values	默认值 Default value	单位 Unit	适用 Apply
	转矩指令直线加减速时间常数	1~30000	1	ms	T

Pn187▲	Torque command linear acceleration and deceleration time constant				
	<p>时间常数定义为转矩指令由零直线上升到额定转矩的时间。The time constant is defined as the time that the torque command rises from zero straight to the nominal torque.</p> <div style="text-align: center;"> </div>				

编号 No.	名称 Name	取值范围 Range of values	默认值 Default value	单位 Unit	适用 Apply
Pn188▲	模拟转矩指令平滑过滤时间 Simulated torque command smoothing filtering time	1~500	5	0.1ms	T
<p>设置值越大，输入模拟量响应速度越慢，有利于减小高频噪声干扰；设置越小，响应速度越快，但干扰噪声会变大。The larger the set value, the slower the input analog response speed is, which is beneficial to reduce the high-frequency noise interference. The smaller the set, the faster the response rate, but the interference noise will become larger.</p>					

编号 No.	名称 Name	取值范围 Range of values	默认值 Default value	单位 Unit	适用 Apply
	模拟转矩指令增益 Analog torque command gain	1-300	30	%/V	T
<p>模拟量转矩指令输入与电机实际输出转矩之间的比例关系。电压输入的范围-10~10V。默认输入电压为10V，电机达到3倍额定转矩，即$Y=KX=30X$，$K=30$。The proportional relationship between the analog torque command input and the actual</p>					

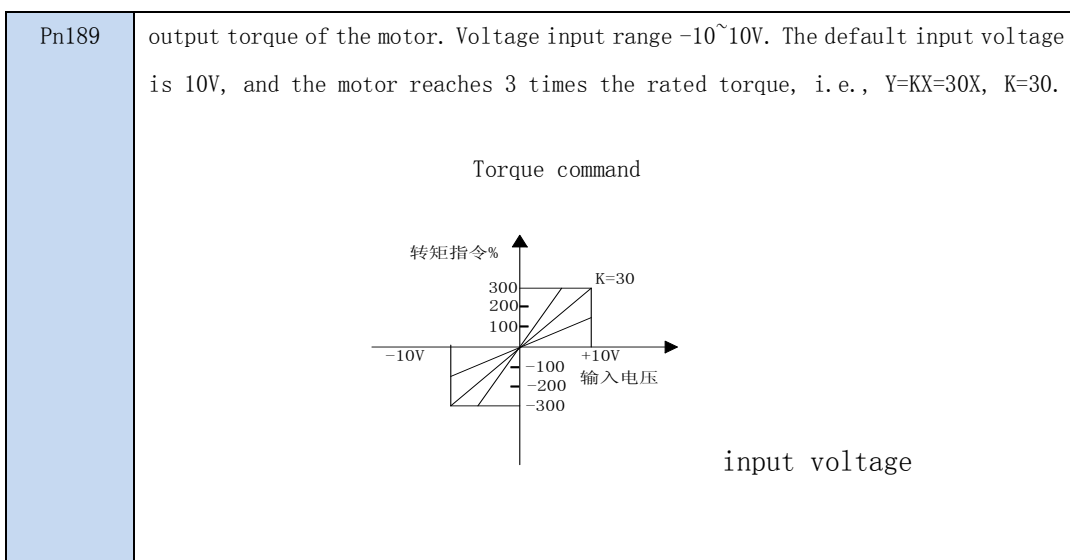

编号 No.	名称 Name	取值范围 Range of values	默认值 Default value	单位 Unit	适用 Apply
Pn190	模拟转矩指令偏移调整 Analog torque command offset adjustment	-1500~1500	0	mv	T
调整方式参考“模拟速度指令偏移调整” Adjustment mode reference "analog speed command offset adjustment"					

编号 No.	名称 Name	取值范围 Range of values	默认值 Default value	单位 Unit	适用 Apply
Pn191	模拟转矩指令方向 Analog torque direction	0-1	0		T
	设置值 Setting value	功能 Function			
	0	正电压正转(ccw), 负电压反转(cw) Positive voltage forward (CCW), negative voltage reversal (CW)			
	1	负电压正转(ccw), 正电压反转(cw) Negative voltage forward (CCW), positive voltage inversion (CW)			

编号 No.	名称 Name	取值范围 Range of values	默认值 Default value	单位 Unit	适用 Apply
Pn192	转矩 Q 轴调节器比例增益 1 Torque Q shaft regulator proportional gain 1	5~2000	100	%	All
Pn193	转矩 Q 轴调节器积分时间常数 1 Torque Q axis regulator integration time constant 1	5~2000	100	%	All
Pn194	转矩 Q 轴调节器比例增益 2 Torque Q shaft regulator proportional gain 2	5~2000	100	%	All
Pn195	转矩 Q 轴调节器积分时间常数 2 Torque Q axis regulator integration time constant 2	5~2000	100	%	All
<ul style="list-style-type: none"> • 增大比例增益, 可使 Q 轴电流响应加快。Increasing the proportional gain can speed up the Q axis current response. • 减小积分时间常数, 可减小 Q 轴电流控制误差。Reducing the integral time constant can reduce the Q axis current control error. 					

编号 No.	名称 Name	取值范围 Range of values	默认值 Default value	单位 Unit	适用 Apply
Pn196	转矩指令滤波时间常数 1 Torque instruction filtering time constant 1	1~5000	40	0.01m s	All
Pn197	转矩指令滤波时间常数 2 Torque instruction filtering time constant 2	1~5000	40	0.01m s	All
<p>可抑制机械振动, 设置值越大, 效果越好, 过大会造成响应变慢, 可能引起振荡; 设置值越小, 响应越快, 但受机械条件限制。The mechanical vibration can be suppressed, the greater the set value, the better the effect, resulting in slower response to the meeting, may cause oscillation; the smaller the set value, the faster the response, but limited by mechanical conditions.</p>					

编号 No.	名称 Name	取值范围 Range of values	默认值 Default value	单位 Unit	适用 Apply
Pn198	转矩控制时限制速度 Limiting speed during torque control	0~4500	2500	r/min	T
<p>在转矩控制时，电机运行速度限制在本参数范围内。可防止轻载时出现超速现象。出现超速时，介入速度控制来减小实际转矩，但实际转速会略有误差。In torque control, the motor speed is limited within this parameter range. It can prevent overspeed during light load. When speeding occurs, the intervention speed control reduces the actual torque, but the actual speed will be slightly error.</p>					

编号 No.	名称 Name	取值范围 Range of values	默认值 Default value	单位 Unit	适用 Apply
	转矩控制受限速度来源选择 Torque control, limited speed, source selection	0~2	0		T

Pn199	设置值 Setting value	功能 Function		
	0	受参数 Pn198 限制。Subject to parameter Pn198 limit.		
	1	受内部速度指令 1~8 限制。Subject to the internal speed command 1~8 limit.		
	2	若 Pn204=1, 即所有转矩指令来源于内部转矩指令, 则速度可受模拟电压速度指令限制。If Pn204=1, that is, all torque commands originate from the internal torque command, the speed can be limited by analog voltage, speed, and instruction.		
<p>• 以上所有速度限制值不分正负, 多个速度限制发生, 受限于最小的速度。All of these speed limits are positive and negative, and multiple speed limits occur, subject to minimal speed.</p> <p>• 若本参数设置为 1, 受内部速度指令限制, 则由 sp1, sp2, sp3 决定受限速度值: If this parameter is set to 1 and limited by the internal speed command, the SP1, SP2, and SP3 determine the limited speed value:</p>				
SP3	SP2	SP1	速度指令 Speed command	
0	0	0	内部速度 1 Internal speed 1	
0	0	1	内部速度 2 Internal speed 2	
0	1	0	内部速度 3 Internal speed 3	
0	1	1	内部速度 4 Internal speed 4	
1	0	0	内部速度 5 Internal speed 5	
1	0	1	内部速度 6 Internal speed 6	
1	1	0	内部速度 7 Internal speed 7	
1	1	1	内部速度 8 Internal speed 8	
0 表示 OFF, 1 表示 ON。0 stands for OFF, and 1 means ON.				
<p>• 即使上述参数设置值超过系统的允许的最高速度, 实际速度也会限制在最高速度以下。</p> <p>Even if the parameter settings exceed the maximum speed allowed by the system,</p>				

	the actual speed will be limited to the maximum speed.
--	--

编号 No.	名称 Name	取值范围 Range of values	默认值 Default value	单位 Unit	适用 Apply															
Pn200	内部转矩 1 Internal torque 1	-300~300	0	%	T															
Pn201	内部转矩 2 Internal torque 2	-300~300	0	%	T															
Pn202	内部转矩 3 Internal torque 3	-300~300	0	%	T															
Pn203	内部转矩 4 Internal torque 4	-300~300	0	%	T															
	<p>选择内部转矩控制模式时, 使用输入端口 SigIn 的 TR1 TR2 可选择 4 种转矩指令: When selecting the internal torque control mode, the TR1 TR2 using the input port SigIn can select 4 torque commands:</p> <table border="1" style="margin-left: 40px;"> <thead> <tr> <th>TR2</th> <th>TR1</th> <th>转矩指令 Torque command</th> </tr> </thead> <tbody> <tr> <td>0</td> <td>0</td> <td>内部转矩 1 或外部模拟转矩指令 (由 Pn204 决定) Internal torque 1 or external analog torque instruction (determined by Pn204)</td> </tr> <tr> <td>0</td> <td>1</td> <td>内部转矩 2 Internal torque 2</td> </tr> <tr> <td>1</td> <td>0</td> <td>内部转矩 3 Internal torque 3</td> </tr> <tr> <td>1</td> <td>1</td> <td>内部转矩 4 Internal torque 4</td> </tr> </tbody> </table> <p>注 1: 0 表示 OFF, 1 表示 ON Note 1: 0 indicates OFF, and 1 stands for ON</p> <p>注 2: 若 SigIn 端口没用指定 TR2, TR1 功能, 默认都是 OFF 状态。Note 2: if the SigIn port does not use the specified TR2, TR1 function, the default is the OFF state.</p>					TR2	TR1	转矩指令 Torque command	0	0	内部转矩 1 或外部模拟转矩指令 (由 Pn204 决定) Internal torque 1 or external analog torque instruction (determined by Pn204)	0	1	内部转矩 2 Internal torque 2	1	0	内部转矩 3 Internal torque 3	1	1	内部转矩 4 Internal torque 4
TR2	TR1	转矩指令 Torque command																		
0	0	内部转矩 1 或外部模拟转矩指令 (由 Pn204 决定) Internal torque 1 or external analog torque instruction (determined by Pn204)																		
0	1	内部转矩 2 Internal torque 2																		
1	0	内部转矩 3 Internal torque 3																		
1	1	内部转矩 4 Internal torque 4																		

编号 No.	名称 Name	取值范围 Range of values	默认值 Default value	单位 Unit	适用 Apply				
	转矩指令来源 Torque command source	0~2	0		T				
Pn204	<table border="1" style="width: 100%;"> <thead> <tr> <th>设置值 Setting value</th> <th>功能 Function</th> </tr> </thead> <tbody> <tr> <td>0</td> <td>外部模拟转矩指令。External analog torque command.</td> </tr> </tbody> </table>		设置值 Setting value	功能 Function	0	外部模拟转矩指令。External analog torque command.			
设置值 Setting value	功能 Function								
0	外部模拟转矩指令。External analog torque command.								

	1	内部转矩 1。Internal torque 1.
	2	运动控制器模拟电压指令。Motion controller analog voltage command.

编号 No.	名称 Name	取值范围 Range of values	默认值 Default value	单位 Unit	适用 Apply
Pn205	转矩 D 轴调节器比例增益 Torque D axis regulator; proportional gain	5~2000	100	%	All
Pn206	转矩 D 轴调节器积分时间常数 Torque D axis regulator, integral time constant	5~2000	100	%	All
空间矢量调制时，转矩 D 轴的调节器的比例增益和积分时间常数。In space vector modulation, the proportional gain and integral time constant of the regulator of the torque D axis.					

编号 No.	名称 Name	取值范围 Range of values	默认值 Default value	单位 Unit	适用 Apply
Pn207	速度反馈调节系数 Speed feedback adjustment factor	1~3000	100		T
	在转矩控制时，电机速度处于限定速度范围以外，介入速度反馈，以减小实际转矩，从而使速度向限制速度范围内回归。参数设置越小，反馈量越大，调整越快，与限制速度相差越小，但太小可能会导致电机抖动；参数设置太大，调整越慢，有可能已经过速度，起不到限速作用。实际转速会略高于限定速度值。In torque control, the motor speed is outside the defined speed range, and the intervention speed feedback is applied to reduce the actual torque, so that the speed is returned to the limited speed range. Parameter setting is smaller, the greater the amount of feedback, adjust more quickly, the difference with the speed limit is small, but too small may cause motor jitter; parameter setting is too large, adjust more slowly, there may have been no limiting speed. The actual speed will be				

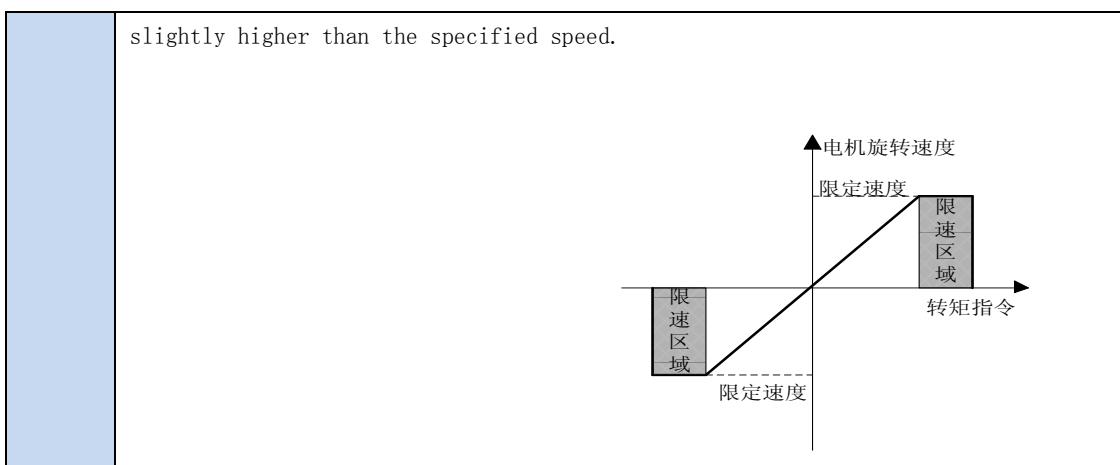

编号 No.	名称 Name	取值范围 Range of values	默认值 Default value	单位 Unit	适用 Apply
Pn208	跟踪转矩指令判断误差范围 1Tracking torque instruction to determine range of error 1	0~300	5	%	T
Pn209	跟踪转矩指令判断误差范围 2Tracking torque instruction to determine range of error 2	0~300	2	%	T
<p>要使 SigOut 端口的 TCMDreach 信号输出有效，必须满足以下条件：To make the SigOut port TCMDreach signal output valid, the following conditions must be met:</p> <p>条件 1: 上位机设定的转矩指令必须在判断误差范围 1 内。例：输入的转矩指令 80%，Pn208 设为 5%，驱动器内部对输入的转矩指令进行加减速运算，当计算输出的转矩指令在 75%~85% 范围内时，条件 1 就得到满足。</p> <p>Condition 1: the torque instructions set by the upper computer must be within 1 of the error range. Example: the input torque command 80%, Pn208 is set to 5%, the driver of the internal torque input speed plus and deceleration operations, when the output torque calculation instructions in the 75%~85% range, the condition 1 is met.</p> <p>条件 2: 检测到的实际电机转矩与输入的转矩指令之差在判断误差范围 2 内。</p> <p>Condition 2: the difference between the actual motor torque and the input torque command is within 2 of the error range.</p>					

编号 No.	名称 Name	取值范围 Range of values	默认值 Default value	单位 Unit	适用 Apply
Pn210	速度限制输出的判定时间 Decision time for speed limited output	0~2000	15	ms	T
<p>转矩控制模式下,当电机转速超出最高速度限制值,在判定时间内持续限速作用时, SigOut 端口的 SPL 功能信号输出 ON, 以减少信号的频繁反转。In the torque control mode, when the motor speed exceeds the maximum speed limit value and the speed limiting function is continued within the decision time, the SPL function signal of the SigOut port is output ON to reduce the frequent inversion of the signal.</p>					

4.3.5 扩展控制参数 Extended control parameter

编号 No.	名称 Name	取值范围 Range of values	默认值 Default value	单位 Unit	适用 Apply
Pn216▲	绝对式编码器用法选择 Absolute encoder usage selection	0~1	1		All
	设置值 Setting value	功能 Function			
	0	单圈绝对式编码器 Single loop absolute encoder			
	1	多圈绝对式编码器 Multi loop absolute encoder			
	2	运动控制器模拟电压指令。Motion controller analog voltage command.			
<p>当没有外接电池时,编码器无法保存多圈信息,此时应设置本参数为0。When there is no external battery, the encoder cannot save multi circle information. This parameter should be set to 0.</p>					

编号 No.	名称 Name	取值范围 Range of values	默认值 Default value	单位 Unit	适用 Apply
Pn217	绝对式编码器输出线数 Absolute encoder output line	16~16384	2500	线	All

	<ul style="list-style-type: none"> 从伺服单元向外部发送的脉冲。输出线数越高，A, B 正交脉冲信号可输出的最高频率 (Max=1.6Mhz) 也越高，对上位机脉冲接收电路的要求越高。较差的接收电路将出现脉冲缺失现象。A pulse transmitted from the outside of the servo unit. The higher the output line, the higher the maximum frequency (Max=1.6Mhz) of the A and B orthogonal pulse signals, and the higher the requirements for the pulse receiver circuit of the host computer. A poor reception circuit will suffer from pulse missing. 默认情况下，Pn217=2500，即电机旋转一圈，伺服单元输出 2500*4=10000 个脉冲。By default, Pn217=2500, that is, the motor rotates one turn, the servo unit outputs 2500*4=10000 pulses. 									
编号 No.	名称 Name	取值范围 Range of values	默认值 Default value	单位 Unit	适用 Apply					
Pn218	绝对式编码器绝对位置数据发送方式 Absolute position data transfer mode for absolute encoder	0~1	0		All					
	<p>当 Pn216 设置为 1，即使用绝对式编码器的多圈数据信息，并且绝对式编码器配备电池，此时将会输出正确的多圈绝对位置信息；若 Pn216 设置为 0，输出的多圈位置信息为 0。详见“第十章绝对式伺服单元的使用”。When Pn216 is set to 1, that the use of multi ring absolute encoder data, and the absolute encoder is equipped with batteries, multi turn absolute position information at this time will output the correct; if Pn216 is set to 0, the output of the multi ring position information for 0. See the use of absolute servo units in chapter tenth".</p> <table border="1" style="margin-left: auto; margin-right: auto;"> <thead> <tr> <th>设置值 Setting value</th> <th>功能 Function</th> </tr> </thead> <tbody> <tr> <td>0</td> <td>增量方式输出多圈绝对位置信息和单圈绝对位置信息 The incremental mode outputs the absolute position information of the circle and the absolute position information of the single circle</td> </tr> <tr> <td>1</td> <td>数字编码方式输出绝对位置信息和单圈绝对位置信息 Digital encoding outputs absolute position information and single loop absolute position information</td> </tr> </tbody> </table>					设置值 Setting value	功能 Function	0	增量方式输出多圈绝对位置信息和单圈绝对位置信息 The incremental mode outputs the absolute position information of the circle and the absolute position information of the single circle	1
设置值 Setting value	功能 Function									
0	增量方式输出多圈绝对位置信息和单圈绝对位置信息 The incremental mode outputs the absolute position information of the circle and the absolute position information of the single circle									
1	数字编码方式输出绝对位置信息和单圈绝对位置信息 Digital encoding outputs absolute position information and single loop absolute position information									

编号 No.	名称 Name	取值范围 Range of values	默认值 Default value	单位 Unit	适用 Apply					
Pn219	绝对式编码器多圈溢出检出 Multi turn overflow detection for absolute encoder	0~1	1		All					
	<p>当作为多圈绝对式编码器使用时，若电机始终单方向运行，有可能导致多圈数据溢出。可设置本参数，关闭多圈溢出报警。When used as a multi loop absolute encoder, if the motor is always running in single direction, it may lead to multi circle data overflow. This parameter can be set to turn off the overflow alarm.</p>									
	<table border="1"> <thead> <tr> <th>设置值 Setting value</th> <th>功能 Function</th> </tr> </thead> <tbody> <tr> <td>0</td> <td>多圈溢出报警不检出 Multi circle overflow alarm not detected</td> </tr> <tr> <td>1</td> <td>多圈溢出报警检出 Multi circle overflow alarm detection</td> </tr> </tbody> </table>		设置值 Setting value	功能 Function	0	多圈溢出报警不检出 Multi circle overflow alarm not detected	1	多圈溢出报警检出 Multi circle overflow alarm detection		
设置值 Setting value	功能 Function									
0	多圈溢出报警不检出 Multi circle overflow alarm not detected									
1	多圈溢出报警检出 Multi circle overflow alarm detection									

编号 No.	名称 Name	取值范围 Range of values	默认值 Default value	单位 Unit	适用 Apply
Pn234	脉冲指令最高频率 Maximum pulse command frequency	20~2000	550	KHZ	P
<p>当指令脉冲频率超过所设定值时，驱动器发出报警。When the instruction pulse frequency exceeds the set value, the driver sends out an alarm.</p>					

编号 No.	名称 Name	取值范围 Range of values	默认值 Default value	单位 Unit	适用 Apply
Pn235	脉冲指令数字滤波时间 Pulse instruction digital filtering time	0~255	0	100ns	P
<ul style="list-style-type: none"> 对输入的指令脉冲进行数字滤波，以滤除信号线上的噪声。The input instruction pulse is filtered digitally to filter the noise on the signal line. 设置时间越大，最高脉冲频率越低。系统默认设置值，允许接收最高 550KH 频率。滤波时间必须留有一定余量，否则可能出现丢失脉冲现象。The greater the setup time, the lower the maximum pulse frequency. System defaults, allowing maximum 550KH frequencies to be 					

	received. Filter time must be left a certain margin, otherwise there may be lost pulse phenomenon.				
编号 No.	名称 Name	取值范围 Range of values	默认值 Default value	单位 Unit	适用 Apply
Pn236	绝对式编码器正向软禁止多圈值 Absolute encoder, forward soft forbidden, multi circle value	0~32000	0	圈-circle	All
Pn237	绝对式编码器正向软禁止单圈值 Absolute encoder, forward soft forbidden, single coil value	0~10000	0	0.0001 圈 0.0001circle	All
Pn238	绝对式编码器反向软禁止多圈值 Absolute encoder, reverse soft forbidden, multi circle value	0~32000	0	圈 circle	All
Pn239	绝对式编码器反向软禁止单圈值 Absolute encoder, reverse soft inhibit, single coil value	0~10000	0	0.0001 圈	All
<p>• 对带绝对式编码器的伺服电机使用编码器的多圈功能时(Pn216=1)，可使用软件驱动禁止功能。软禁止功能等同由外部端口(CCWL, CWL)触发的驱动禁止功能，可配合 P007, Pn077 参数使用。For servo motors with absolute encoders, use the encoder's multi turn function (Pn216=1) and use software driver disable function. The soft disable function is equivalent to a drive disable function triggered by an external port (CCWL, CWL) that can be used in conjunction with the P007 and Pn077 parameters.</p> <p>• 参数设置为 0（默认值）时，软禁止功能无效，反之，当电机所转圈数达到设置值时，软禁止功能将被触发。例：Pn236=100, Pn237=5000, 则当电机正向旋转超出 100+5000*0.0001=100.5 圈时，触发驱动禁止功能。When the parameter is set to 0 (default), the soft disable function is invalid. Otherwise, when the number of turns of the motor reaches the set value, the soft disable function will be triggered. Example: Pn236=100, Pn237=5000, triggers the drive disable function when the motor is rotated forward beyond the 100+5000*0.0001=100.5 loop.</p>					

编号 No.	名称 Name	取值范围 Range of values	默认值 Default value	单位 Unit	适用 Apply
-----------	---------	----------------------------	-------------------------	------------	-------------

Pn257	负载转动惯量比 Load inertia ratio	0~100.00	1.00	倍 times	PS
<p>负载转动惯量比 = $\frac{\text{电机轴换算的转动惯量(JL)}}{\text{转子转动惯量(Jm)}}$。Load torque ratio = (JL of motor shaft translation) (/ rotor inertia (Jm)) 出厂时, 假定伺服电机带有一倍负载惯量的状态。 When leaving the factory, the servo motor is assumed to have a double load inertia state.</p>					

编号 No.	名称 Name	取值范围 Range of values	默认值 Default value	单位 Unit	适用 Apply
Pn258	增益调整模式 Gain adjustment mode	0~1	0	-	PS
	设置值 Setting value	功能 Function			
	0	手动增益调整。Manual gain adjustment.			
	1	自动增益调整, 调整方法详见”运行与调整”章节。For automatic gain adjustment, see the chapter on “operation and adjustment”.			

编号 No.	名称 Name	取值范围 Range of values	默认值 Default value	单位 Unit	适用 Apply
Pn259	刚性等级选择 Rigid grade selection	0~20	5	-	PS
<p>刚性等级越高, 伺服响应越快, 但过高的刚性等级会引起电机振动, 设置方法详见”运行与调整”章节。The higher the rigidity, the faster the servo response, but the higher rigidity will cause the motor vibration. The method of setting is detailed in the chapter “operation and adjustment”.</p>					

编号 No.	名称 Name	取值范围 Range of values	默认值 Default value	单位 Unit	适用 Apply

Pn260	惯量实时推定方式 Real-time estimation method of inertia	0~1	0	-	All
	设置值 Setting value	功能 Function			
	0	离线惯量推定。通过 Fn018 操作进行惯量识别。Off-line inertia estimation. Identification of inertia by Fn018 operation.			
1	在线惯量推定。电机运行时，进行实时推定，通过 Dn030 查看负载惯量比。On-line inertia estimation. When the motor is running, the real-time estimation is made and the load inertia ratio is checked by Dn030.				

编号 No.	名称 Name	取值范围 Range of values	默认值 Default value	单位 Unit	适用 Apply
Pn263◆	惯量推定加减速时间 Inertia estimation acceleration and deceleration time	20~500	80	ms	All
Pn264◆	惯量推定允许最高速度 Inertia estimation allows maximum speed	150~1000	400	r/min	All
Pn265◆	惯量推定暂停时间间隔 Inertia estimation pause interval	0~10000	500	ms	All
Pn266◆	惯量推定惯量比预估 Inertia estimation; inertia ratio; prediction value	1.00~20.00	3.00	倍	All
	详见”运行与调整”章节之系统惯量识别。See system reliability identification in chapter "operation and adjustment".				

编号 No.	名称 Name	取值范围 Range of values	默认值 Default value	单位 Unit	适用 Apply
--------	---------	-------------------------	----------------------	---------	-------------

Pn267▲	电机额定转矩 Rated torque of motor	0~32000	0	0.1N.m	All
Pn268▲	电机最大输出转矩 Maximum output torque of motor	0~32000	0	0.1N.m	All
Pn269▲	电机转子转动惯量 Jm Motor rotor moment of inertia Jm	0~32000	0	Kg·M ² ·10 ⁻⁴	All
Pn270▲	电机最大转速 Maximum motor speed	80~5500	80	r/min	All
	必须依据电机铭牌参数进行设置。错误的参数设置将影响电机运行性能，导致电机非正常旋转。默认情况下，按驱动器内部参数取值。Must be set according to motor nameplate parameters. The wrong parameter setting will affect the motor performance, resulting in abnormal rotation of the motor. By default, drive the internal parameters of the drive.				

4.4 端口功能详解 Port function detail

4.4.1 SigIn 输入端口功能详解 SigIn input port function detailed

编号 NO.	符号 Symbol	功能 Function	功能说明 Function description
0	NULL	无功能指定 Nonfunctional assignment	驱动器对输入状态不产生任何动作。The drive does not generate any action on the input state.
1	Son	伺服使能 Servo enable	OFF: 驱动器不使能，电机不通电。 OFF: the drive doesn't work, the motor doesn't work. ON: 驱动器使能，电机通电 ON: driver enable, motor powered 注: Pn003 参数或 Son 状态决定。 Note: the Pn003 parameter or the Son status is determined.
2	AlarmRst	报警复位 Alarm reset	有报警时，且该报警可以清除时，输入信号上升沿（OFF 到 ON）时，清除该报警。When the alarm is on, and when the alarm can be cleared, the input signal rising edge (OFF to ON) is used to clear the alarm.
3	CCWL	正转驱动禁止 Forward drive inhibit	OFF: 禁止电机正转 OFF: prohibits the motor going forward ON: 允许电机正转 ON: allow the motor to turn

			<p>注 1: 若要使用正转驱动禁止功能, 先设置 Pn006 参数, 开启该功能, 再指定到特定的输入端口。默认, 不使用该功能。Note 1: if you want to use the forward drive disable function, first set the Pn006 parameter, turn on the function, and then specify the specific input port. By default, this function is not used.</p> <p>注 2: 电机正常运行时, CCWL 必须处于常闭触点 (ON 状态) Note 2: when the motor is in normal operation, the CCWL must be in normally closed contact (ON state)</p> <p>注 3: 原点回归时, 本功能无效。Note 3: this function is invalid when origin returns.</p>
4	CWL	反转驱动禁止 Reverse drive inhibit	<p>OFF: 禁止电机反转 OFF: prohibits motor inversion</p> <p>ON: 允许电机反转 ON: allow the motor to reverse</p>
5	TCCW	外部正转转矩限制 External forward torque limit	<p>OFF: CCW 方向转矩不受 Pn010 参数限制 OFF: CCW torque is not limited by the Pn010 parameter</p> <p>ON: CCW 方向转矩受 Pn010 参数限制 ON: CCW direction torque is limited by the Pn010 parameter</p> <p>注: 不管 TCCW 有效还是无效, CCW 方向转矩还受 Pn008 参数限制。Note: no matter whether TCCW is valid or invalid, the CCW direction torque is limited by the Pn008 parameter.</p>
6	TCW	外部反转转矩限制 External reverse torque limit	<p>OFF: CW 方向转矩不受 Pn011 参数限制 OFF: CW torque is not limited by the Pn011 parameter</p> <p>ON: CW 方向转矩受 Pn011 参数限制 ON: CW direction torque is limited by the Pn011 parameter</p> <p>注: 不管 TCW 有效还是有无效, CW 方向转矩还受 Pn009 参数限制。Note: no matter whether TCW is valid or invalid, the CW direction torque is limited by the Pn009 parameter.</p>
7	EMG	紧急停机 Emergency shutdown	<p>OFF: 禁止驱动器驱动电机, 切断电机电流 OFF: prohibits drive drive motors, cutting motor currents</p> <p>ON: 允许驱动器正常驱动电机 ON: allows drivers to drive motors normally</p>
8	ZeroLock	零速箝位 Zero speed	速度控制时: Speed control:

		clamping	OFF: 不锁电机轴 OFF: does not lock the motor shaft ON : 锁住电机轴 ON: Lock the motor shaft																																				
9	SP1	内部速度指令选择 1 Internal speed command select 1	<p>当驱动器的控制模式处于速度控制模式时，速度指令来源由 SigIn 的 SP1, SP2, SP3 决定：</p> <table border="1"> <thead> <tr> <th>SP3</th> <th>SP2</th> <th>SP1</th> <th>速度指令 Speed command</th> </tr> </thead> <tbody> <tr> <td>0</td> <td>0</td> <td>0</td> <td>内部速度 1/ Internal speed 1 外部模拟 external analog 速度指令 (Pn168 选择) Speed command (Pn168 selection)</td> </tr> <tr> <td>0</td> <td>0</td> <td>1</td> <td>内部速度 2 Internal speed 2</td> </tr> <tr> <td>0</td> <td>1</td> <td>0</td> <td>内部速度 3 Internal speed 3</td> </tr> <tr> <td>0</td> <td>1</td> <td>1</td> <td>内部速度 4 Internal speed 4</td> </tr> <tr> <td>1</td> <td>0</td> <td>0</td> <td>内部速度 5 Internal speed 5</td> </tr> <tr> <td>1</td> <td>0</td> <td>1</td> <td>内部速度 6 Internal speed 6</td> </tr> <tr> <td>1</td> <td>1</td> <td>0</td> <td>内部速度 7 Internal speed 7</td> </tr> <tr> <td>1</td> <td>1</td> <td>1</td> <td>内部速度 8 Internal speed 8</td> </tr> </tbody> </table> <p>注 1: 0 表示 OFF, 1 表示 ON。 Note 1: 0 indicates OFF, and 1 stands for ON.</p> <p>注 2: 若 SigIn 端口没有指定 SP3, SP2, SP1 功能，默认都是 OFF 状态。 Note 2: if the SigIn port does not specify SP3, SP2, and SP1 functions, the default is the OFF state.</p>	SP3	SP2	SP1	速度指令 Speed command	0	0	0	内部速度 1/ Internal speed 1 外部模拟 external analog 速度指令 (Pn168 选择) Speed command (Pn168 selection)	0	0	1	内部速度 2 Internal speed 2	0	1	0	内部速度 3 Internal speed 3	0	1	1	内部速度 4 Internal speed 4	1	0	0	内部速度 5 Internal speed 5	1	0	1	内部速度 6 Internal speed 6	1	1	0	内部速度 7 Internal speed 7	1	1	1	内部速度 8 Internal speed 8
SP3	SP2	SP1		速度指令 Speed command																																			
0	0	0		内部速度 1/ Internal speed 1 外部模拟 external analog 速度指令 (Pn168 选择) Speed command (Pn168 selection)																																			
0	0	1		内部速度 2 Internal speed 2																																			
0	1	0		内部速度 3 Internal speed 3																																			
0	1	1		内部速度 4 Internal speed 4																																			
1	0	0		内部速度 5 Internal speed 5																																			
1	0	1		内部速度 6 Internal speed 6																																			
1	1	0	内部速度 7 Internal speed 7																																				
1	1	1	内部速度 8 Internal speed 8																																				
10	SP2	内部速度指令选择 2 Internal speed command select 2																																					
11	SP3	内部速度指令选择 3 Internal speed command select 3																																					
12	TR1	内部转矩指令选择 1 Internal torque command select 1	<p>选择内部转矩控制模式时，利用 TR1、TR2 组合，可选择 4 种转矩指令。 Select the internal torque control mode, the use of TR1, TR2 combination, you can select 4 torque commands.</p> <table border="1"> <thead> <tr> <th>TR2</th> <th>TR1</th> <th>转矩指令 Torque command</th> </tr> </thead> <tbody> <tr> <td>0</td> <td>0</td> <td>内部转矩 1/外部模拟转矩指令 (Pn204 选择) Internal torque 1/ external analog torque command (Pn204 selection)</td> </tr> <tr> <td>0</td> <td>1</td> <td>内部转矩 2 Internal torque 2</td> </tr> <tr> <td>1</td> <td>0</td> <td>内部转矩 3 Internal torque 3</td> </tr> </tbody> </table>	TR2	TR1	转矩指令 Torque command	0	0	内部转矩 1/外部模拟转矩指令 (Pn204 选择) Internal torque 1/ external analog torque command (Pn204 selection)	0	1	内部转矩 2 Internal torque 2	1	0	内部转矩 3 Internal torque 3																								
TR2	TR1	转矩指令 Torque command																																					
0	0	内部转矩 1/外部模拟转矩指令 (Pn204 选择) Internal torque 1/ external analog torque command (Pn204 selection)																																					
0	1	内部转矩 2 Internal torque 2																																					
1	0	内部转矩 3 Internal torque 3																																					
13	TR2	内部转矩指令选择 2 Internal torque command select 2																																					

			<table border="1"> <tr> <td>1</td> <td>1</td> <td>内部转矩 4 Internal torque 4</td> </tr> </table> <p>注 1:0 表示 OFF,1 表示 ON Note 1:0 indicates OFF, and 1 stands for ON</p> <p>注 2: 若 SigIn 端口没用指定 TR2, TR1 功能, 默认都是 OFF 状态。 Note 2: if the SigIn port does not use the specified TR2, TR1 function, the default is the OFF state.</p>	1	1	内部转矩 4 Internal torque 4												
1	1	内部转矩 4 Internal torque 4																
14	Cmode	控制模式切换 Control mode switching	参数 Pn002 为 3、4、5 时, 可进行控制方式切换。When the parameter Pn002 is 3, 4, and 5, control mode switching can be carried out.															
15	Cgain	增益切换 Gain switching	当参数 Pn045 为 2 时, 通过 Cgain 切换增益组合: When the parameter Pn045 is 2, the Cgain switches the gain combination: OFF: 第一增益 OFF: first gain ON: 第二增益 ON: second gain															
16	Gn1	电子齿轮分子选择 1 Electronic gear molecule selection 1	通过 Gn1、Gn2 组合, 选择电子齿轮分子 1~4 Select the electronic gear molecule Gn2 through the combination of Gn1 and 1~4															
17	Gn2	电子齿轮分子选择 2 Electronic gear molecule selection 2	<table border="1"> <tr> <td>Gn2</td> <td>Gn1</td> <td>电子齿轮比分子 N Electronic gear ratio, molecular N</td> </tr> <tr> <td>OFF</td> <td>OFF</td> <td>第 1 分子 First molecule</td> </tr> <tr> <td>OFF</td> <td>ON</td> <td>第 2 分子 Second molecule</td> </tr> <tr> <td>ON</td> <td>OFF</td> <td>第 3 分子 Third molecule</td> </tr> <tr> <td>ON</td> <td>ON</td> <td>第 4 分子 Fourth molecule</td> </tr> </table>	Gn2	Gn1	电子齿轮比分子 N Electronic gear ratio, molecular N	OFF	OFF	第 1 分子 First molecule	OFF	ON	第 2 分子 Second molecule	ON	OFF	第 3 分子 Third molecule	ON	ON	第 4 分子 Fourth molecule
Gn2	Gn1	电子齿轮比分子 N Electronic gear ratio, molecular N																
OFF	OFF	第 1 分子 First molecule																
OFF	ON	第 2 分子 Second molecule																
ON	OFF	第 3 分子 Third molecule																
ON	ON	第 4 分子 Fourth molecule																
18	CINV	指令取反 Instruction fetch	速度或转矩控制模式下, 速度或转矩的指令取反。In speed or torque control mode, the speed or torque is reversed. OFF: 正常指令 OFF: normal instruction ON: 指令取反 ON: instruction is reversed															

19	Pclear	位置偏差清除 Clearance of position deviation	清除位置偏差计数器的值，清除方式由 Pn108 参数确定： Clears the value of the position counter, and the clearing method is determined by the Pn108 parameter: <table border="1"> <thead> <tr> <th>Pn108</th> <th>方式 mode</th> </tr> </thead> <tbody> <tr> <td>0</td> <td>Pclear 电平 ON 期间 Pclear Level ON period</td> </tr> <tr> <td>1</td> <td>Pclear 上升沿时刻(由 OFF 到 ON) Pclear rising edge time (from OFF to ON)</td> </tr> </tbody> </table>	Pn108	方式 mode	0	Pclear 电平 ON 期间 Pclear Level ON period	1	Pclear 上升沿时刻(由 OFF 到 ON) Pclear rising edge time (from OFF to ON)
Pn108	方式 mode								
0	Pclear 电平 ON 期间 Pclear Level ON period								
1	Pclear 上升沿时刻(由 OFF 到 ON) Pclear rising edge time (from OFF to ON)								
20	INH	脉冲输入禁止 Pulse input inhibit	OFF: 输入指令脉冲有效 OFF:The input command pulse is valid ON : 输入指令脉冲无效，被忽略 ON: the input command pulse is invalid and ignored						
21	PC	比例控制 Proportional control	速度环为 PI 控制结构 (Pn182=100) 时: The speed loop is the PI control structure (Pn182=100): OFF:速度环 PI 控制 OFF: speed loop PI control ON:速度环 P 控制 ON: speed loop P control						
22	GOH	原点回归触发 Origin regression trigger	详见附录 F See Appendix F for details						
23	REF	原点回归参考点 Origin regression reference point							
24	Pos1	内部位置选择 pos1 Internal location selection pos1	详见附录 G See Appendix G for details						
25	Pos2	内部位置选择 pos2 Internal location selection pos2							
26	ptriger	触发内部位置指令 Trigger internal position command							
27	pstop	暂停内部位置指令 Pause internal position command							
28	Psource	内外位置指令选择	在 Pn117=2 时，脉冲指令来源可由 Psource 确定: At						

		Internal and external position instruction selection	Pn117=2, the source of the pulse command is determined by the Psource: OFF: 外部位置指令 OFF: external location command On : 内部位置指令 ON: Internal position command
29	Pdistance	定长位移中断 Fixed length displacement interrupt	当 SigIn:Pdistance 由 On 变为 Off 时, 驱动器将执行定长功能, 详见附录 H When SigIn:Pdistance is changed from On to Off, the drive will perform a fixed length function, as shown in Appendix H
30	Punlock	定长解锁 Fixed length unlock	在 Pn139=1 时, 执行完定长距离后, 伺服处于定长锁定状态, 只有当 sigIn:Punlock 由 On 变长 Off 后, 驱动器才能正常响应位置指令。 详见附录 H At Pn139=1, the servo is in a fixed length lock state after a long distance, and the drive can respond to the position instructions only when the sigIn:Punlock is longer than Off from the On. See Appendix H for details
31	Sen	绝对位置请求 Absolute location request Absolute location request	用于上位机读取绝对式编码器的绝对位置信息, 详见“第十章绝对式伺服单元的使用” For absolute position information of absolute encoder for upper computer, see the use of absolute servo unit in the tenth chapter”

4.4.2 SigOut 输出端口功能详解 SigOut output port function detailed

编号 NO.	符号 Symbol	功能 FUnction	功能说明 Function description
0	null	无功能指定 Nonfunctional assignment	
1	Alarm	报警检出 Alarm detection	OFF:有报警 OFF: alarm ON: 无报警 ON: No alarm
2	Ready	伺服准备好 Servo ready	OFF:有报警或故障 OFF: has alarm or a fault ON:无报警与故障 ON: no alarm and fault
3	Emg	紧急停止检出 Emergency stop detection	OFF:没有处于紧急停止状态 OFF: Not in an emergency stop ON : 处于紧急停止状态 ON: in an emergency stop

4	Preach	定位完成 Location complete	位置控制模式时 Position control mode OFF: 位置偏差大于参数 Pn104 设定的值 OFF: position deviation is greater than the value set by the parameter Pn104 ON: 位置偏差小于等于参数 Pn104 设定的值 ON: position deviation is less than the value set by the parameter Pn104
5	Sreach	速度到达 Speed arrival	OFF:速度小于 Pn021 设定的值 OFF: speed is less than the value set by Pn021 ON: 速度大于等于 Pn021 设定的值 ON: the speed is greater than or equal to the value set by Pn021
6	Treach	到达预定转矩 Arrival torque	OFF: 转矩小于 Pn024 设定的值 OFF: torque less than Pn024 setting value ON: 转矩大于等于 Pn024 设定的值 ON: torque greater than or equal to the value set by Pn024
7	ZeroSpeed	零速 Zero speed	OFF:速度大于 Pn027 设定的值 OFF: speed is greater than the value set by Pn027 ON: 速度小于等于 Pn027 设定的值 ON: the speed is less than or equal to the value set by Pn027
8	Run	伺服电机通电 Servo motor energized	OFF:电机没有通电 OFF: motor is not energized ON:电机通电 ON: motors are energized
9	BRK	电磁制动 Electromagneti c braking	OFF: 电磁制动器制动 OFF: electromagnetic brake ON : 电磁制动器释放 ON: electromagnetic brake release
10	HOME	原点回归完成 Origin regression complete	详见附录 F 。 See Appendix F for details
11	Pnear	定位接近 Positioning approach	处于位置控制时 In position control OFF: 位置偏差大于参数 Pn106 设定的值 OFF: position deviation is greater than the value

			<p>set by the parameter Pn106</p> <p>ON:位置偏差小于等于参数 Pn106 设定的值 ON: position deviation is less than the value set by the parameter Pn106</p>
12	TRQL	<p>转矩限制中</p> <p>Torque limit</p>	<p>OFF: 电机转矩没有被限制</p> <p>OFF: motor torque is not limited</p> <p>ON: 电机转矩被限制 ON: motor torque is limited</p> <p>当转矩指令达到 Pn008, Pn009, Pn010, Pn011 中的最小参数值时, TRQL 为 ON。When the torque command reaches the minimum parameter value in Pn008, Pn009, Pn010, and Pn011, the TRQL is ON.</p>
13	SPL	<p>速度限制中</p> <p>Speed limit</p>	<p>转矩控制时 Torque control</p> <p>OFF: 电机速度没有达到限制值</p> <p>OFF: motor speed is not up to the limit</p> <p>ON: 电机速度已达到限制值 ON: motor speed has reached the limit value</p> <p>参见 Pn198, Pn199 说明。See Pn198, Pn199 for instructions</p>
14	TCMDreach	<p>跟踪转矩指令到达 Tracking torque command arrives</p>	<p>处于转矩控制时: At torque control:</p> <p>OFF: 电机转矩没有到达上位机设定的转矩指令值</p> <p>OFF: the motor torque does not reach the torque command value set by the upper computer</p> <p>ON: 电机转矩到达上位机设定的的转矩指令值</p> <p>参见 Pn208 、Pn209 说明. ON: the motor torque reaches the set torque command value set by the upper computer, See the Pn208 and Pn209 instructions</p>

第5章 监控参数与操作

The fifth chapter monitoring parameters and operation

5.1 监控面板操作 Monitor panel operation

详见第三章的“[监控模式操作](#)”。See the "monitor mode" operation in chapter third".

5.2 监控参数一览表 List of monitoring parameters

编号 NO.	说明 Explain
dn-00	监控显示选项（默认为电机运行速度），通过设置 Pn079 参数，使 dn-00 显示不同的监控状态。Monitor display options (default for motor speed) by setting the Pn079 parameter so that the dn-00 displays different monitoring states.
dn-01	速度指令(单位: r/min) Speed command (unit: r/min)
dn-02	平均转矩(单位: %) Average torque (unit:%)
dn-03	位置偏差量(-9999~9999) (单位: 个) Position deviation (-9999~9999) (unit: bit)
dn-04	交流电源电压(单位: 伏) AC power supply voltage (unit: volt)
dn-05	最大瞬时力矩(单位: %) Maximum instantaneous torque (unit:%)
dn-06	脉冲输入频率(单位: KHZ) Pulse input frequency (unit: KHZ)
dn-07	散热片温度(单位: ℃) Temperature of radiator (unit: Celsius)
dn-08	当前电机运行速度(单位: r/min) Current motor speed (unit: r/min)
dn-09	有效输入指令脉冲累计值低位(-9999~9999) (单位: 个) Effective input instruction pulse accumulated value low (-9999~9999) (unit: bit)
dn-10	有效输入指令脉冲累计值高位(-5000~5000) (单位: 万个) (脉冲累计值高位超出±5000, 则高位置0, 低位不变, 重新计数) Effective input instruction pulse accumulated value high (-5000~5000) (unit: 10000bit) (pulse accumulation value is higher than +5000, then high position 0, low bit unchanged, count again)
dn-11	位置控制时, 编码器有效反馈脉冲累计值低位(-9999~9999) (单位: 个) In position control, the effective feedback pulse accumulated value of encoder is low (-9999~9999) (unit: bit)
dn-12	位置控制时, 编码器有效反馈脉冲累计值高位(-5000~5000) (单位: 万个) (反馈脉冲累计值高位超出±5000, 则高位置0, 低位不变, 重新计数) Position control, the encoder effective

	feedback pulse accumulation value high (-5000~5000) (unit: 10000) (feedback pulse accumulation value is higher than + 5000, then high position 0, low bit unchanged, re count)
dn-13	再生制动负载率 Regenerative braking load rate
dn-14	输入端口信号状态, 从左至右依次为 SigIn1~SigIn10 (数码管上半段亮: 高电平; 下半段亮: 低电平) The input port signal status, from left to right, is SigIn1~SigIn10 (the upper half of the digital tube is bright: high level, lower half is bright: low level)
dn-15	输出端口信号状态, 从左至右依次为 SigOut1~SigOut5 (数码管上半段亮: 高电平; 下半段亮: 低电平) The output port signal status, from left to right, is SigOut1~SigOut5 (the upper half of the digital tube is bright: high level, lower half is bright: low level)
dn-16	电机使能时, 模拟转矩指令电压(单位: 伏) When the motor is enabled, the analog torque is indicated by voltage (unit: volts)
dn-17	电机使能时, 模拟速度指令电压(单位: 伏) When the motor is enabled, the analog speed is indicated by voltage (unit: volts)
dn-18	输出功能状态寄存器 Output function status register
dn-19	伺服上电后, 电机的反馈脉冲累计值低位 (-9999~9999) (单位: 个) After the servo is powered on, the feedback pulse value of the motor is low (-9999~9999) (unit: bit)
dn-20	伺服上电后, 电机的反馈脉冲累计值高位 (-5000~5000) (单位: 万个) (反馈脉冲累计值高位超出±5000, 则高位置 0, 低位不变, 重新计数) After the servo power, the motor feedback pulse accumulation value is high (-5000~5000) (unit: 10000bit) (the feedback pulse accumulation value is higher than + 5000, then high position 0, low position unchanged, count again)
dn-21	驱动器软件版本 Drive software version
dn-22	编码器 UVW 信号从左至右依次为 UVW 信号的电平状态 (1: 高电平; 0: 低电平) (增量式编码器) The encoder UVW signals, from left to right, are the level states of the UVW signal (1: high level, 0: low level) (incremental encoder)
dn-23	转子绝对位置 (增量式编码器) Absolute position of rotor (incremental encoder)
dn-24	驱动器型号 Driver type
dn-25	绝对值编码器单圈数据低位(0~9999) (单位: 个) Absolute value encoder, single loop data low (0~9999) (unit: bit)
dn-26	绝对值编码器单圈数据高位(0~9999) (单位: 万个) Absolute encoder, single loop data high bit (0~9999) (unit: 10000bit)
dn-27	绝对值编码器多圈数据低位(-9999~9999) (单位: 圈) Absolute value encoder, multi circle data low bit (-9999~9999) (unit: circle)

dn-28	绝对值编码器多圈数据高位(-9999~9999) (单位: 万圈) Absolute value encoder, multi loop data high bit (-9999~9999) (unit: ten thousands circle)
dn-30	负载转动惯量比 Load inertia ratio

注: Dn-18 输出功能状态寄存器即 SigOut 端口的功能逻辑状态, 各 Bit 位如下表所示: Note: the Dn-18 outputs the functional status register, i.e., the functional logic status of the SigOut port, as shown in the table below for each Bit bit:

Bit 位	Bit7	Bit6	Bit5	Bit4	Bit3	Bit2	Bit1	Bit0
功 能 function	Run	ZeroSpeed	Treach	Sreach	Preach	Emg	Ready	Alarm
Bit 位	Bit15	Bit14	Bit13	Bit12	Bit11	Bit10	Bit9	Bit8
功 能 function	-	-	TCMDreach	SPL	TRQL	Pnear	HOME	BRK

Bit 位为 0, 表示功能为 ON 状态, 为 1 则是 OFF 状态。The Bit bit is 0, which means that the function is ON, and the 1 is the OFF state.

第 6 章报警及处理

The sixth chapter, alarm and treatment

6.1 报警清除操作 Alarm clearing operation

详见第三章的辅助模式操作的“[报警清除操作](#)”。See the "alarm clearing" operation of the auxiliary mode operation in chapter third".

6.2 警报内容与对策 Alert content and Countermeasures

警报显示 Alarm display	清除方式 Cleanup mode	异常报警说明 Abnormal alarm declaration	排除方法 Removal method
AL-01	重新上电 Power up	存储器内容被破坏或存储器芯片损坏 Memory	1: 对参数进行初始化, 观察情况。1: initialization of the parameters, observe the situation.

	again	contents corrupted or memory chip corrupted	<p>2: 通过 modbus 通信方式与按键操作方式同时进行了对参数的编辑操作, 可能导致校验码出错, 引发报警。</p> <p>2: through the Modbus communication mode and the button operation mode, edit the operation of the parameter simultaneously, which may lead to the mistake of the check code and cause the alarm.</p> <p>2: 内部芯片损坏, 更换伺服放大器。2: internal chip damage, replace servo amplifier.</p>
AL-02	重置 Reset	在低压不足警报开启的情况下, 直流母线电压低于 200V 时发出的警报。An alarm that occurs when the DC bus voltage is below 200V when the low voltage alarm is not turned on.	<p>1: 用电压表测量外部电源电压是否符合规格。如果符合规格, 可使用辅助模式 Fn009, 进行母线电压校正。</p> <p>1: use voltmeter to measure whether the external power supply voltage meets the specifications. If the specifications are met, the bus voltage correction can be carried out using the auxiliary mode Fn009.</p> <p>2: 通过显示屏面板, 进入监控模式, 观察显示的电压是否与外部电压一致, 若相差过大, 则内部元件损坏, 更换伺服放大器。2: through the display panel, enter the monitoring mode, observe whether the voltage is consistent with the external voltage, if the difference is too large, then the internal components damaged, replace servo amplifier.</p> <p>3: 电机负载大, 启动速度过快, 导致内部母线电压被拉低。如果是单相电源接入, 请用三相电源接入。3: the motor load is large, the starting speed is too fast, leading to the internal bus voltage is low. If it is a single-phase power supply, please use three-phase power supply.</p>
AL-03	重新上电 Power up again	内部直流母线电压过高 The internal DC bus voltage is too high	<p>1: 用电压表测量外部电源电压是否符合规格。如果符合规格, 可使用辅助模式 Fn009, 进行母线电压校正。</p> <p>1: use voltmeter to measure whether the external power supply voltage meets the specifications. If the specifications are met, the bus voltage correction can be carried out using the auxiliary mode Fn009.</p> <p>2: 通过显示屏面板, 进入监控模式, 观察显示的电压</p>

			<p>是否与外部电压一致，若相差过大，则内部元件损坏，更换伺服放大器。2: through the display panel, enter the monitoring mode, observe whether the voltage is consistent with the external voltage, if the difference is too large, then the internal components damaged, replace servo amplifier.</p> <p>3: 在合理的范围内，适当减速小负载惯量或延长加减速时间，否则需要另加制动电阻。3: within a reasonable range, appropriate deceleration of small load inertia or extended acceleration and deceleration time, or need additional brake resistance.</p>
AL-04	重新上电 Power up again	智能功率模块直接产生的报警 Intelligent power module generates alarms directly	<p>1: 检查电动力线 U,V,W 是否相间短路或对地短路，以及编码器线是否正常连接。1: check the motor power line U, V, W whether the interphase short circuit or ground short circuit, and encoder line is normal connection.</p> <p>2: 散热片温度高，关闭电源，30 秒后重新上电，如果报警依旧出现，可能内部功率模块损坏，请更换伺服放大器。2: heat sink high temperature, turn off the power, 30 seconds after the re power, and if the alarm still appears, the internal power module may be damaged, please replace the servo amplifier.</p> <p>3:速度环、电流环比例积分参数设置不当。3: speed loop and current loop proportional integral parameter are not set properly.</p>
AL-05	重置 Reset	过载 1 Overload 1	<p>Pn014 参数设定的时间内，持续大于过载能力参数 Pn012 或 Pn013 所设定倍数的电流。In the Pn014 parameter setting, the current is continuously greater than the overload power parameter Pn012 or the set multiple of the Pn013.</p> <p>1: 检查电机线 U,V,W 及编码器线是否正常。1: check the motor line U, V, W and encoder line is normal.</p> <p>2:电机加减速频率过高，延长加减速时间、减小负载</p>

			惯量或换选更大功率容量的伺服电机。The acceleration and deceleration frequency of the 2: motor is too high to prolong the acceleration and deceleration time, reduce the load inertia or change the servo motor with greater power capacity.
AL-06	重新上电 Power up again	过载 2 Overload 2	Pn015 参数设定的时间内,持续大于额定负载 3 倍。排除方法参考过载 1。The Pn015 parameter is set to 3 times longer than the rated load during the set time. The method of elimination referred to overload 1. 注: 有些电机只能承受额定负载的 2.5 或 2 倍, 则不按 3 倍作为计算。Note: some motors can only withstand 2.5 or 2 times the rated load, but not 3 times as the calculation.
AL-07	重置 Reset	电机转速过高 Motor speed is too high	1: 检查电机线 U,V,W 及编码器线是否正常。 2: 降低输入指令的脉冲频率, 或调整电子齿轮比。 3: 速度环比例积分参数调整不当, 重新调整。
AL-08	重置 Reset	伺服放大器散热片过热, 实际温度已超过 Pn084 设定值 The servo amplifier heatsink is overheated and the actual temperature has exceeded the Pn084 setpoint	1: 重复过载会造成驱动器过热, 请更改电机运行方式。为延长伺服器的寿命, 应在环境温度 60℃ 以下使用, 推荐温度不要超过 50℃。1: repeated overload can cause overheating of the drive. Please change the way the motor works. To extend the service life of the server, it should be used at ambient temperature below 60 degrees, and the recommended temperature is not more than 50 degrees celsius. 2: 制动平均功率过载。2: braking average power overload.
AL-09	重新上电 Power up again	编码器异常 Encoder exception	1: 检查电机编码器接线是否连接到驱动器。1: check whether the motor encoder connection is connected to the driver. 2: 检查电机编码器接口是否虚焊、短路或脱落, 编码器电源线是否正常连接。2: check whether the motor encoder interface weld, short-circuit or fall off, the encoder power line is connected properly. 3: 检查编码器的供电电压(5V±5%)。(编码器线较长

			时, 需要特别注意) 3: check the encoder power supply voltage (5V + 5%). (the encoder line needs to be paid special attention when it is longer)
AL-10	重置 Reset	实际接收脉冲频率过高, 超过 Pn234 设定值 The actual received pulse frequency is too high to exceed the Pn234 setpoint	1: 降低输入指令的脉冲频率 1: reduces the pulse frequency of the input command
AL-11	重置 Reset	位置脉冲偏差量大于设定值 The position pulse deviation is greater than the setpoint	1: 检查电机线 U, V, W 及编码器线是否正常。 1: check the motor line U, V, W and encoder line is normal. 2 位置指令平滑时间常数设置过大。 2 position instruction smoothing time constant is set too large. 3: 加大位置环增益, 以加快电机的反应速度。 3: increases the position loop gain to speed up the motor response. 4: 利用监视模式, 查看电机输出扭力是否达到极限。 4: use monitoring mode to see if the motor output torque is up to its limit. 5: 内部 32 位脉冲计数器溢出。 5: internal 32 bit pulse counter overflow.
AL-12	重置 Reset	电流采样回路可能损坏。 The current sampling loop may be damaged.	1: 瞬时电流过大, 超出可检测的范围。 1: instantaneous current is too large to exceed detectable range. 2: 检查电机线 (U, V, W) 是否松动脱落或对地短路等异常连接现象。 2: check the motor line (U, V, W) whether it is loose, falling or short connection to the ground. 3: 采样回路损坏, 更换伺服放大器。 3: sampling loop corrupted, replace servo amplifier.
AL-13	重新上电 Power up	CPU 内部故障 CPU internal fault	1: 外部干扰过大, 降低干扰。 1: external interference is too large to reduce interference.

	again		2:CPU 芯片损坏, 更换伺服放大器。2:CPU chip corrupted, replace servo amplifier.
AL-14	重置 Reset	紧急停止信号有效 Emergency stop signal is valid	查看端口, 是否设置的紧急停止功能, 信号触点是否处于常闭状态(ON) See if the port has an emergency stop function and whether the signal contact is in a normally closed state (ON)
AL-15	重置 Reset	驱动禁止异常,Ccwl或Cwl为 OFF 状态 Driver forbidden exception, Ccwl or Cwl as OFF state	1:检查 CCWL,CWL 接线, 信号触点是否处于常闭状态(ON)。1: check CCWL, CWL wiring, signal contact is in normally closed state (ON). 2:若不使用驱动禁止功能, 可设置 pn006 参数, 将其屏蔽。2: if you do not use the drive disable function, you can set the pn006 parameter to mask it.
AL-16	重置 Reset	输入电源电压过高或制动负载率达到 85%以上 The input voltage is too high or the braking load rate is above 85%	1:使用监视模式查看输入电压是否超出正常范围 1: uses monitor mode to see if the input voltage is beyond normal range 2:降低起停频率 2: reduces start stop frequency 3:外接更大功率的再生制动电阻(去掉内部制动电阻, 不能与之并联) 3: external regenerative braking resistor (remove internal braking resistor, not parallel) 4:增加减速时间 4: increases deceleration time 5:再生电阻功率值和电阻值是否设置正确 5:Are the power and resistance values of the regenerative resistors set correctly? 6:更换更大功率的电机和驱动器 6: replace more power motors and drives
AL-17	重新上电 Power up again	设置的编码器输出分频比不当。Improper encoder output frequency division.	重新设置 Pn016, Pn017 参数值, 必须满足 DA/DB>=1。 To reset the Pn016, the Pn017 parameter value must satisfy DA/DB>=1.
AL-18	重新上电 Power up again	当前驱动器型号不支持设定的电机型号 The current driver model does not support the set motor type	参考驱动器与电机型号适配表, 重新设置 Pn001。Refer to the drive and motor model adapter to reset the Pn001.

AL-19	重置 Reset	功率模块过热 Power module overheating	功率模块温度过高，发热严重，需冷却一段时间，否则将降低模块使用寿命。The temperature of the power module is too high and the heating is serious. It needs to be cooled for a period of time. Otherwise, the service life of the module will be reduced.
AL-20	重新上电 Power up again	同一功能指派给多个输入端口 The same function is assigned to multiple input ports	查看所有 SigIn 端口，去除重复设置的端口。View all SigIn ports and remove duplicate ports.
AL-21	重新上电 Power up again	存储器内容完全破坏 Memory contents are completely destroyed	1:对参数进行初始化，观察情况。若再频繁出现报警，请更换伺服放大器。1: initializes the parameters and looks at the situation. If alarm occurs again frequently, replace servo amplifier. 2:内部芯片损坏，更换伺服放大器。2: internal chip damage, replace servo amplifier.
AL-22	重新上电 Power up again	看门狗定时器溢出 Watchdog timer overflow	1:重新上电。若反复出现，请更换伺服放大器。1: power on again. Replace the servo amplifier if it occurs again and again. 2:外部外扰过大，降低外部干扰。2: external interference is too large to reduce external interference.
AL-23	重新上电 Power up again	电流零漂补偿异常 Current zero drift compensation anomaly	1: 重新上电，若反复出现，电流采样回路元器件可能损坏。1: re power, if repeated, the current sampling loop components may be damaged.
AL-24	重新上电 Power up again	可编程逻辑芯片异常 Programmable logic chip exception	1:重新上电。若反复出现，请更换伺服放大器。1: power on again. Replace the servo amplifier if it occurs again and again. 2:外部外扰过大，降低外部干扰。2: external interference is too large to reduce external interference.
AL-25	重新上电 Power up again	DSP 芯片异常 DSP chip abnormalities	重新上电。若反复出现，请更换伺服放大器。Power up again. Replace the servo amplifier if it occurs again and again..

AL-26	重新上电 Power up again	不支持的原点回归组合 Unsupported origin regression combination	参考附录 F, 重新设置 Pn034, Pn035. Refer to appendix F, reset Pn034, Pn035.
AL-27	重新上电 Power up again	外置制动电阻阻值小于驱动器型号允许最小阻值。 The external braking resistance is less than the drive type, allowing minimum resistance.	重新选购外置制动电阻。Replace the external brake resistor.
AL-28	重新上电 Power up again	制动电阻再生过载率超过 Pn090 设定值, 电阻表面已产生较高的温升。必须待电阻冷却 15 分钟以上再上电, 否则短时连续重新上电工作, 有可能导致电阻烧毁, 引发火灾。The regenerative rate of the braking resistor is more than the Pn090 setting, and the resistance surface has a higher temperature rise. Must be resistance to cooling for more than 15 minutes, then power, or short-term continuous re power work, may lead to the resistance to burn, causing fire.	1 进入 Dn013, 查看制动电动再生负载率。1 enter the Dn013 and check the brake electric regenerative load rate.
AL-29	重新上电 Power up again	伺服短时持续制动异常 Servo short duration brake abnormal	1 进入 Dn004, 查看输入电源电压是否过高。1 enter the Dn004 to see if the input voltage is too high. 2 接线脱落或未接制动电阻 2 wiring off or no braking resistance

AL-31	重新上电 Power up again	绝对式编码器电池低压警告 Absolute encoder battery low voltage warning	电池电压低于 $3.1 \pm 0.1V$ 。请立即更换电池，否则将丢失多圈数据。The battery voltage is less than $3.1 + 0.1V$. Please replace the battery immediately, otherwise you will lose multi circle data.
AL-32	重新上电 Power up again	绝对式编码器电池电压过低 Absolute encoder battery voltage is too low	已出现电池电压低于 $2.5 \pm 0.2V$ 的情形。检查电池是否松动；电池电压是否正常。请执行 Fn015 操作，复位多圈信息，以解除报警。A case where the battery voltage is below $2.5 + 0.2V$ has occurred. Check if the battery is loose and the battery voltage is normal. Please perform the Fn015 operation and reset the multi circle information to relieve the alarm.
AL-33	重新上电 Power up again	绝对式编码器多圈计数溢出 Absolute encoder multi turn count overflow	伺服在上电或断电期间，多圈计数器计数超出计数边界。请执行 Fn015 操作，复位多圈信息。若实际应用中，无需进行多圈溢出检测，可设置 Pn219 参数，关闭多圈溢出报警。During servo or power off, the multi loop counter counts beyond the count boundary. Perform the Fn015 operation to reset the multi loop information. If there is no need for multiple loop overflow detection in the actual application, the Pn219 parameter can be set to turn off the multi ring overflow alarm.
AL-34	重新上电 Power up again	绝对式编码器计数错误 Absolute encoder count error	上电期间，电机转速过高。请重新上电。During the power up, the motor speed is too high. Power up again, please.
AL-35	重新上电 Power up again	绝对式编码器上电错误 Absolute encoder power error	编码器上电时，电机在旋转，且速度高于 100r/min。上电时，电机须处于静止或较低速状态。When the encoder is powered on, the motor rotates and the speed is higher than 100r/min. When power is on, the motor must be in a stationary or low speed state.
AL-36	重新上电 Power up again	绝对式编码器多圈错误 Absolute encoder multi turn error	多圈计数发生错误。请执行 Fn015 操作，复位多圈信息。Error occurred in multi circle count. Perform the Fn015 operation to reset the multi loop information.
AL-37	重新上电	电机过热 Motor	1 电机内部温度超过 $110^{\circ}C$ ，请冷却一段时间。

	Power up again	overheating	<p>1 motor temperature over 110 degrees, please cool for some time.</p> <p>2 电机超额使用, 请使用容量更大的电机 2 motor over use, please use a larger capacity of the motor</p>
AL-38	重新上电 Power up again	绝对式编码器检测到过速报警 Absolute encoder detects excessive speed alarm	未接电池或电池电压过低; 电池正常而驱动器未接电源, 电机因外部转动加速度过大。请检查电池, 再执行 Fn015 操作, 复位多圈信息。No battery or battery voltage is too low, the battery is normal and the drive does not receive the power supply, the motor rotates due to external acceleration. Please check the battery, and then perform the Fn015 operation to reset the multi loop information.
AL-41	重新上电 Power up again	通信故障, 绝对式编码器无响应 Communication fault, absolute encoder without response	<p>1: 检查电机编码器接插接是否连接到驱动器。1: check whether the motor encoder connector is connected to the drive.</p> <p>2: 检查电机编码器接口是否虚焊、短路或脱落; 编码器信号线接线顺序是否正确; 编码器电源线是否正常连接。2: check whether the motor encoder interface weld, short circuit or off; encoder signal wire sequence whether the power line is connected properly; encoder.</p> <p>3: 编码器损坏。3: encoder damage.</p>
AL-42	重新上电 Power up again	绝对式编码器通信时, 连续出错次数过多 Absolute encoder communication, the number of errors in succession too much	<p>1: 检查电机编码器接插件是否接触不良, 编码器线是否过长。1: check the motor, encoder, connector is bad contact, encoder line is too long.</p> <p>2: 检查编码器电缆的布线, 尽量避免与电机线、电源线等强干扰源缠绕, 应保持相当距离。2: check the encoder cable wiring, as far as possible to avoid with the motor line, power line and other strong interference source winding, should keep a considerable distance.</p> <p>3: 编码器接口电路故障 3: encoder interface circuit fault</p>

			4: 外部干扰过大, 降低外部干扰 4: too much external interference, reduce external interference
AL-43	重新上电 Power up again	绝对式编码器内部存储单元数据出错 Absolute encoder internal storage unit data error	存储单元未初始化或数据已破坏, 请执行 Fn017 操作, 重新初始化数据。The storage cell is uninitialized or the data has been corrupted. Please perform the Fn017 operation and re initialize the data.
AL-44	重新上电 Power up again	绝对式编码器分频电路故障 Absolute encoder frequency divider circuit fault	编码器异常或电机运行速度过高 Encoder abnormal or motor running too fast
AL-45	重新上电 Power up again	复位绝对式编码器多圈错误操作 Reset, absolute encoder, multi turn error operation, error	参考 AL-42 处理措施 Refer to AL-42 handling measures
AL-46	重新上电 Power up again	复位绝对式编码器单圈错误操作 Reset absolute encoder single turn error operation error	参考 AL-42 处理措施 Refer to AL-42 handling measures

6.3 其它故障现象及处理措施 Other fault phenomena and treatment measures

在伺服驱动器没有发出报警的情况下, 出现的故障情况及处理措施如下表。若处理后仍不能消除异常情况, 请与本公司技术人员联系。In case the servo driver does not give an alarm, the failure conditions and treatment measures are as follows. If you still can not eliminate the abnormal situation after treatment, please contact our technical staff.

故障现象 Fault phenomenon	原因 Reason	检查方法及处理措施 Inspection methods and treatment measures
	控制电源未接通 The control power is not connected	检查控制电源端子间的电压 Check the voltage between the terminals of the control power
	主电路电源未接通 The main circuit power is not connected	检查主电源端子间的电压 Check the voltage between the main power terminals
	控制线 (CN2 连接器) 接线错误或脱落	检查 CN2 连接器的安装和配线 Check the

伺服电机无法启动运转 The servo motor doesn't start running	Control line (CN2 connector) wiring error or fall off	installation and wiring of the CN2 connector
	伺服使能(SON)输入为 OFF 状态 The servo enable (SON) input is in the OFF state	检查输入针是否有脱落、接错, 查看 Dn014 显示的端口输入状态; 也可直接设置驱动器内部使能 (Pn003=1) Check that the input pin is falling off or connected to the wrong position. Check the port input status displayed by Dn014; You can also set the drive internal enable (Pn003=1) directly
	输入的转矩、速度或位置指令太小、为零或没有 The torque, speed, or position of the input is too small to be zero or zero	检查输入针是否有脱落、接错; 增大输入指令; 转矩、速度或位置指令源选择参数设置与预期不符 Check whether the input pins fall off or connect wrong; increase the input command; torque, speed or position, command source selection, parameter settings inconsistent with expectations
	上位机发出的脉冲指令, 驱动器没有响应 The pulse command issued by the host computer does not respond to the driver	检查输入针是否有脱落, 接线顺序是否错乱; 查看 Dn006, 接受脉冲频率是否与上位机发出的频率一致; 检查电机是否工作在位置模式及处于使能状态; 检查 SigIn 端口是否指定 Pclear 和 INH 功能, 且信号所处状态是否有效 Check the input pin is off, whether the terminal sequence of insanity; see Dn006, accept the same frequency and pulse frequency is from the upper PC; check the motor is working in position mode and be enabled; check whether the SigIn port specified by Pclear and INH, and the signal of the state is valid
	错误指定输入端口功能号 Error specifying the input port function number	检查 SigIn 端口功能参数设定是否正确 Check that the SigIn port function parameter is set correctly
系统负载过大 System load is too large	进行无载 JOG 试运行, 查看驱动器是否正常运行 Perform no-load JOG test to see if the drive is running properly	

	偏移脉冲清除 (Pclear) 保持 ON 状态 Offset pulse clearing (Pclear) keeps the ON state	检查 Pclear 输入信号、端口和接线, 查看 Dn014 显示的端口输入状态 Check the Pclear input signal, port, and wiring to see the port status of the Dn014 display
	正转驱动禁止 (CCWL)、反转驱动禁止 (CWL) 输入信号保持 OFF 状态 Forward drive, inhibit (CCWL), reverse drive, inhibit (CWL) input signal, maintain OFF status	检查 CCWL、CWL 输入信号、端口和接线, 查看 Dn014 显示的端口输入状态 Check the CCWL, CWL input signals, ports, and wiring to see the port status of the Dn014 display
	电动力线 (UVW) 接线错误 Motor power line (UVW) wiring error	检查动力线接线次序是否正确 Check power line connection order is correct
	伺服驱动器故障 Servo driver fault	驱动器内部线路板故障, 须进行维修 The driver's internal wiring board fault must be repaired
	转矩限制有效 Torque limit valid	内部或外部转矩限制值 (Pn008~Pn011) 有效且限制值过小 Internal or external torque limit values (Pn008~Pn011) are valid and limited values are too small
	指令脉冲频率太低 The instruction pulse frequency is too low	指令脉冲输入方式不正确, 查看 Dn007 显示输入的脉冲频率; 电子齿轮比 (Pn098~Pn112) 分子分母之比过小; 指令脉冲输入方式 (Pn096) 与上位机发出的脉冲方式不符, 接线顺序有误 The instruction pulse input frequency pulse input is not correct, see the Dn007 display; electronic gear ratio (Pn098~Pn112) molecular denominator of the ratio is too small; the instruction pulse input (Pn096) pulse emitted and PC does not match the connection order is wrong
	速度控制时处于零速箝位状态 The speed control is in the zero speed clamping state	SigIn: zero_Lock 信号为 On 状态; 在零速箝位电平 (Pn165) 范围之内; The SigIn:zero_Lock signal is the On state; at the zero speed clamping level (Pn165) range;
伺服电机瞬间运行后停止不动	电机线接线错误 Wiring fault of motor line	检查电动力线接线次序是否正确 Check motor power line connection order is

The servo motor stops running after an instant operation	编码器线接线错误 Wiring fault of motor line	correct 检查编码器接线次序是否正确 Check the encoder wiring order is correct
--	-------------------------------------	--

第 7 章 Modbus 串口通信

The seventh chapter is Modbus serial communication

7.1 Modbus 通信简介 Introduction to Modbus Communications

本驱动器具有 RS-232 和 RS-485 通信接口,用户可以选择一种接口与驱动器通信。通信方法采用 Modbus 传输协议,可使用下列两种通信模式:ASCII (AmericanStandard Code for information interchange) 模式和 RTU(Remote Terminal Unit)模式。在通信前,须先设置好与通信相关的参数(Pn064~Pn071)。The driver has the RS-232 and RS-485 communication interface, and the user can select an interface to communicate with the driver. The communication method uses the Modbus transfer protocol, and the following communication modes can be used: ASCII (AmericanStandard Code for information interchange) mode and RTU (Remote Terminal Unit) mode (). Before communication, you must first set up communication related parameters (Pn064~Pn071).

7.1.2 编码含义 Coding meaning

ASCII 模式: ASCII mode:

每个 8-bit 数据由两个 ASCII 字符组成。例如:一个 1-byte 数据 78H (十六进制表示法),以 ASCII 码表示,包含了 '7' 的 ASCII 码 (37H) 和 '8' 的 ASCII 码 (38H)。Each 8-bit data consists of two ASCII characters. For example, a 1-byte data 78H (sixteen decimal notation) is represented by the ASCII code, which contains the '7' ASCII code (37H) and the '8' ASCII code (38H).

数字 0 至 9、字母 A 至 F 的 ASCII 码,如下表: ASCII numbers from 0 to 9, letters A through F, as follows:

字符符号 Character symbol	'0'	'1'	'2'	'3'	'4'	'5'	'6'	'7'
对应 ASCII 码 Corresponding ASCII code	30H	31H	32H	33H	34H	35H	36H	37H
字符符号 Character symbol	'8'	'9'	'A'	'B'	'C'	'D'	'E'	'F'
对应 ASCII 码 Corresponding ASCII code	38H	39H	41H	42H	43H	44H	45H	46H

RTU 模式: RTU mode:

每个 8-bit 数据由两个 4-bit 的十六进制数据组成, 即一般十六进制组成的数。例如: 十进制 120 用 1-byte 的 RTU 数据表示为 78 H。Each 8-bit data consists of two 4-bit sixteen hexadecimal data, that is, the general number of sixteen components. For example, the decimal 120 is represented by the 1-byte data of RTU as 78 H.

7.1.3 数据结构 data structure

10bit 字符模式 (用于 7bit 数据) 10bit character mode (for 7bit data)

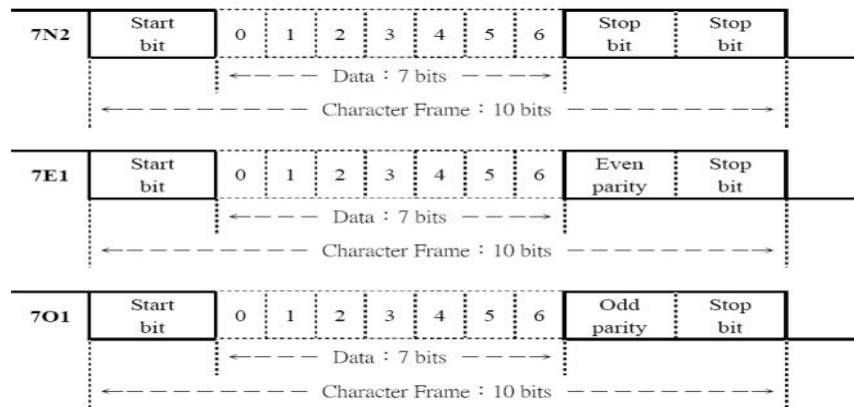

11bit 字符模式 (用于 8bit 数据)

11bit character mode (for 8bit data)

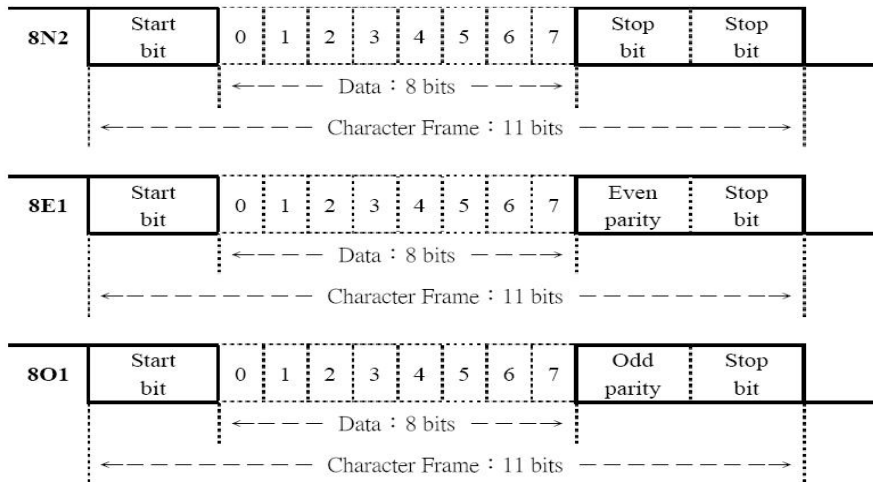

7.2 通信协议结构 Communication protocol architecture

7

● ASCII 模式 ASCII mode

名称 Name	含义 Meaning	说明 instruction
Start	通信开始 Communication begins	起始字符 ':' (ASCII: 3AH) Starting character ':' (ASCII: 3AH)
Address	通信地址 Communication address	通信地址，即驱动器的站点号。例如：某驱动器站点号为 32，十六进制为 20H, Address = '2', '0' 即 '2'=32H, '0'=30H Communication address, that is the site number of the drive. For example: a drive site number is 32, sixteen hexadecimal is 20H, Address = '2', '0', that is '2'=32H, '0'=30H
CMD	命令 Command	1 字节包含 2 个 ASCII 码。常用命令：03H(读寄存器)、06H (读单个寄存器), 08H (诊断功能)、10H(写多个寄存器) The 1 byte contains 2 ASCII codes. Common commands: 03H (read register), 06H (read individual register), 08H (diagnostic function), 10H (write multiple registers)
DATA(n-1)	数据内容 Data content	N 个字=2N 个字节=4N 个 ASCII 码 (N<=8) N words, =2N bytes, =4N ASCII (N<=8)
.....		

DATA(0)		
LRC	校验码 Check code	1 字节包含 2 个 ASCII 码 The 1 byte contains 2 ASCII codes
End 1	结束码 1 End code 1	0DH, 即 CR 0DH, that is, CR
End 0	结束码 0 End code 0	0AH, 即 LF 0AH, that is LF

● RTU 模式

名称 Name	含义 Meaning	说明 instruction
Start	通信开始 Communication begins	至少 3.5 个字节传输时间的静止时段 A quiescent period of at least 3.5 bytes of transmission time
Address	通信地址 Communication address	通信地址, 即驱动器的站点号。例如: 某驱动器站点号为 32, 十六进制为 20H, Address =20H Communication address, that is the site number of the drive. For example, a drive site number is 32, and sixteen is 20H, Address =20H
CMD	命令 Command	1 字节。常用命令: 03H(读寄存器)、06H ((读单个寄存器), 08H (诊断功能)、10H(写多个寄存器) 1 bytes. Common commands: 03H (read register), 06H (read individual register), 08H (diagnostic function), 10H (write multiple registers)
DATA(n-1)	数据内容 Data content	N 个字=2N 个字节 (N<=8) N words, =2N bytes (N<=8)
.....		
DATA(0)		
CRC	校验码 check code	1 字节 1 bytes
End 1	结束 End	至少 3.5 个字节传输时间的静止时段 A quiescent period of at least 3.5 bytes of transmission time

7.3 常用命令码 Common command code

7.3.1 读多个寄存器 Read multiple registers

03H: 读多个寄存器 03H: read multiple registers

说明：读取 N 个字，N 为 1~8 范围内取值 Description: read N words, N for 1~8 range value

例：从站点号为 01H 的驱动器上读取起始地址 0013H 开始的 2 个字。Example: read the 2 words at the start address 0013H from the drive on the site number "01H".

1. ASCII 模式 ASCII mode

上位机->驱动器
PC - upper monitor

start		‘:’
Address		‘0’
		‘1’
cmd		‘0’
		‘3’
数据起始地址 Data start address	高位 High position	‘0’
		‘0’
	低位 Low position	‘1’
		‘3’
读寄存器个数 read number of registers		‘0’
		‘0’
		‘0’
		‘2’
LRC		‘E’
		‘7’
END1(CR)		0DH
END0(LF)		0AH

回应->上位机 (OK)
In responser- upper monitor (OK)

start		‘:’
Address		‘0’
		‘1’
cmd		‘0’
		‘3’
数据字节数 Data bytes		‘0’
		‘4’
地址 0013H 内容 address 0013H content	高位 High position	‘0’
		‘0’
	低位 Low position	‘3’
		‘2’
地址 0014H 内容 address 0014H content	高位 High position	‘0’
		‘0’
	低位 Low position	‘0’
		‘A’
LRC		‘B’
		‘C’
END1(CR)		0DH
END0(LF)		0AH

回应->上位机 (Error)
In responser- upper monitor (Error)

start		‘:’
Address		‘0’
		‘1’
cmd		‘8’
		‘3’
异常码 Exception code		‘0’
		‘2’
LRC		‘7’
		‘A’
END1(CR)		0DH
END0(LF)		0AH

2. RTU 模式 RTU mode

上位机->驱动器
PC - upper monitor

回应->上位机 (OK)
In responser- upper
monitor (OK)

回应->上位机
(Error) In
responser-
upper monitor
(Error)

Address		01H
CMD		03H
数据起始 地址 Data start address	高位 High position	00H
		13H
读寄存器个数 read number of registers		00H
		02H
CRC 低位 CRC low position		35H
CRC 高位 CRC High position		CEH

Address		01H
CMD		03H
数据字节数 Data bytes		04H
0013H 地 址的内容 The content of the 0013H address	高位 High position	00H
	低位 low position	32H
0014H 地 址的内容 The content of the 0014H address	高位 High position	00H
	低位 low position	0AH
CRC 低位 CRC position		DBH
CRC 高位 CRC High position		FBH

Address	01H
CMD	83H
异常码 Exception code	02H
CRC 低位 CRC position	C0H
CRC 高位 CRC High position	F1H

7.3.2 写单个寄存器 Write single register

06H: 写单个寄存器 Write single register

说明：写一个字到寄存器。Description: writes a word to the register.

例如：驱动器站号为 01，写数据起始地址为 0013H，写入数据 100(64H)。For example, the drive station number is 01, and the write data start address is 0013H, and the data 100 (64H) is written.

1.ASCII 模式 ASCII Mode

上位机->驱动器
PC - upper monitor

start			‘.’
Address	高位		‘0’
	Low position		‘1’
cmd	0x01		‘0’
	0x06		‘6’
数据起始地址 Data start address	高位 High position	0x00	‘0’
		0x00	‘0’
	低位 Low position	0x01	‘1’
		0x03	‘3’
数据内容 (word 格式) Data content (word format)	0x00		‘0’
	0x00		‘0’
	0x06		‘6’
	0x04		‘4’
LRC	0x08		‘8’
	0x02		‘2’
END1(CR)			0DH
END0(LF)			0AH

回应->上位机(OK)
In responser- upper monitor (OK)

start			‘.’
Address	高位		‘0’
	Low position		‘1’
cmd	0x01		‘0’
	0x06		‘6’
数据起始地址 Data start address	高位 High position	0x00	‘0’
		0x00	‘0’
	低位 Low position	0x01	‘1’
		0x03	‘3’
数据内容 (word 格式) Data content (word format)	0x00		‘0’
	0x00		‘0’
	0x06		‘6’
	0x04		‘4’
LRC	0x08		‘8’
	0x02		‘2’
END1(CR)			0DH
END0(LF)			0AH

回应->上位机(Error)
In responser- upper monitor (Error)

start			‘.’
Address	高位		‘0’
	Low position		‘1’
cmd	0x08		‘8’
	0x06		‘6’
异常码 Exception code	0x00		‘0’
	0x03		‘3’
LRC	0x07		‘7’
	0x06		‘6’
END1(CR)			0DH
END0(LF)			0AH

2. RTU 模式 RTU mode

上位机->驱动器 PC
- upper monitor

Address		01H
CMD		06H
数据起始地址 Data start address	高位 High position	00H
	低位 low position	13H
数据内容 (word 格式) Data content (word format)		00H
		64H
CRC 低位 CRC low position		79H
CRC 高位 CRC High position		E4H

回应->上位机 (OK) In
responser- upper monitor (OK)

Address		01H
CMD		06H
数据起始地址 Data start address	高位 High position	00H
	低位 low position	13H
数据内容 (word 格式) Data content (word format)	F4H	00H
	48H	64H
CRC 低位 CRC low position		79H
CRC 高位 CRC High position		E4H

回应->上位机 (Error) In
responser- upper monitor (Error)

Address	01H
CMD	86H
异常码 Exception code	03H
CRC 低位 CRC low position	02H
CRC 高位 CRC High position	61H

7.3.3 诊断 Diagnosis

08H: 诊断功能 08H: diagnostic function

说明: 使用子功能码 0000H, 检查在 Master 和 Slaver 之间的传输信号。数据内容可为任意数。Instructions: use the sub function code 0000H to check the transmission signals between Master and Slaver. The data content can be any number.

例如: 对站点为 01H 的驱动器使用诊断功能。For example, use diagnostic features for a site 01H driver.

1. ASCII 模式 ASCII Mode

上位机->驱动器
PC - upper monitor

start		‘.’
Address		‘0’
		‘1’
cmd		‘0’
		‘8’
子功能 码 Sub functio n code	高位 High positio n	‘0’
		‘0’
	低位 Low positio n	‘0’
		‘0’
数据内容 (word 格式) Data content (word format)		‘8’
		‘6’
		‘3’
		‘1’
LRC		‘4’
		‘0’
END1(CR)		0DH
END0(LF)		0AH

回应->上位机 (OK)
In responser- upper
monitor (OK)

start		‘.’	
Address		‘0’	
		‘1’	
cmd		‘0’	
		‘8’	
子功能 码 Sub functio n code	高位 High positio n	‘0’	
		‘0’	
	低位 low positio n	‘0’	
		‘0’	
数据内 容(word 格式) Data content (word format)		高位 High positio n	‘8’
			‘6’
		低位 low positio n	‘3’
			‘1’
LRC		‘4’	
		‘0’	
END1(CR)		0D H	
END0(LF)		0A H	

回应->上位机(Error)
In responser-
upper monitor
(Error)

start	‘.’
Address	‘0’
	‘1’
cmd	‘8’
	‘8’
异常码 Exception code	‘0’
	‘3’
LRC	‘7’
	‘4’
END1(CR)	0DH
END0(LF)	0AH

例如：将 100 (0064H)、300 (012CH) 写到站号为 01 伺服驱动器的起始地址 0013H 的连续两个寄存器中。For example, write 100 (0064H) and 300 (012CH) to the station number 01, the two consecutive registers of the start address 0013H of the servo drive.

1. ASCII 模式 ASCII Mode

上位机->驱动器
PC - upper monitor

回应->上位机 (OK) In
responser- upper monitor
(OK)

回应->上位机
(Error)

In responser-
upper monitor
(Error)

start		‘.’
Address		‘0’
		‘1’
cmd		‘1’
		‘0’
数据起始地址 Data start address	高位 High position	‘0’
		‘0’
	低位 low position	‘1’
		‘3’
写寄存器个数 Read number of registers		‘0’
		‘0’
		‘0’

start		‘.’
Address		‘0’
		‘1’
cmd		‘1’
		‘0’
数据起始地址 Data start address	高位 High position	‘0’
		‘0’
	低位 low position	‘1’
		‘3’
写寄存器个数 number of registers	高位 High position	‘0’
		‘0’
	低位 low	‘0’

start		‘.’
Address		‘0’
		‘1’
cmd		‘9’
		‘0’
异常码 Exception code	‘0’	
	‘3’	
LRC	‘6’	
	‘C’	
END1(CR)		0DH
END0(LF)		0AH

		'2'
数据字节数 Data bytes		'0'
		'4'
写数据到 0013H Write data to 0013H	高位 High position	'0'
		'0'
	低位 low position	'6'
		'4'
写数据到 0014H Write data to 0014H	高位 High position	'0'
		'1'
	低位 low position	'2'
		'C'
LRC		'4'
		'5'
END1(CR)		0DH
END0(LF)		0AH

	position	'2'
LRC		'4'
		'1'
END1(CR)		0DH
END0(LF)		0AH

7

2. RTU 模式 RTU Mode

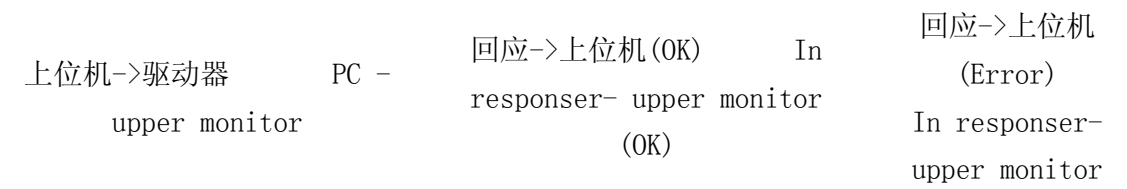

(Error)

Address		01H
CMD		10H
数据起始地址 Data start address	高位 High position	00H
	低位 low position	13H
写寄存器个数 Write number of registers	高位 High position	00H
	低位 low position	02H
数据字节数 Data bytes		04H
写数据到 0013H Write data to 0013H	高位 High position	00H
	低位 low position	64H
写数据到 0014H Write data to 0014H	高位 High position	01H
	低位 low position	2CH
CRC 低位 CRC low position		F3H
CRC 高位 CRC High position		24H

Address		01H
CMD		10H
数据起始地址 Data start address	高位 High position	00H
	低位 low position	13H
写寄存器个数 Write number of registers	高位 High position	00H
	低位 low position	02H
CRC 低位 CRC low position		B0H
CRC 高位 CRC High position		0DH

Address	01H
CMD	90H
异常码 Exception code	03H
CRC 低位 CRC low position	0CH
CRC 高位 CRC High position	01H

注 1: 寄存器一律为 16 位有符号整数。Note 1: registers are all 16 bit signed integers.

注 2: 读取 Dn-13 参数时, 实际电压值=读取值/100。Note 2: when reading the Dn-13 parameter, the actual voltage value = read value /100.

7.3.5 校验码计算 Check code calculation

1. LRC 校验 LRC check

ASCII 模式采用 LRC (Longitudinal Redundancy Check) 校验码。LRC 校验是计算 Address、CMD、起始数据地址及数据内容之总和, 将总和结果以 256 为单位, 取余数 (若总和结果为 150H, 则只取 50H) 后, 再计算其补码, 最后得到的结果为 LRC 校验码。ASCII mode uses LRC (Longitudinal, Redundancy, Check) checksum.

LRC check is the sum of the calculation of Address and CMD, starting data address and data content, the sum of the result by 256 units, take the remainder (if the sum of the result is 150H, only 50H), and then calculate the complement, the final results obtained for LRC check code.

例: 从站点 01 H 伺服驱动器的 0013 地址读取 2 个字 (word)。

Example: read 2 words (word) from the 0013 address of the site 01 H servo driver.

start		‘:
Address		‘0’
		‘1’
cmd		‘0’
		‘3’
数据起始地址 Data start address	高位 High position	‘0’
		‘0’
	低位 low position	‘1’
		‘3’
读寄存器个数 Read Number of registers		‘0’
		‘0’
		‘0’
		‘2’
LRC		‘E’
		‘7’
END1(CR)		0DH

END0(LF)	0AH
----------	-----

从 Address 的数据加至最后一个数据: Add the data from Address to the last data:

01 H +03H+00H+13H+00H+02H=19H,因 19H 的补码为 E7H, 所以 LRC 为 'E', '7'

01H+03H+00H+13H+00H+02H=19H, because 19H's complement is E7H, so LRC is 'E','7'

2. CRC 校验 CRC check

RTU 模式采用 CRC (Cyclical Redundancy Check) 校验码。循环冗余校验 (CRC) 域为两个字节, 包含一个二进制 16 位值。附加在报文后面的 CRC 的值由发送设备计算。接收设备在接收报文时重新计算 CRC 的值, 并将计算结果于实际接收到的 CRC 值相比较。如果两个值不相等, 则为错误。Rtu mode is used CRC (Cyclical Redundancy Check) check code. The cyclic redundancy check (CRC) field is two bytes, containing a binary 16 bit value. The value of the CRC appended to the message is computed by the sending device. The receiving device re calculates the value of the CRC when the message is received, and compares the calculated result with the actual received CRC value. If the two values are not equal, they are wrong.

CRC 的计算, 开始对一个 16 位寄存器预装全 1。然后将报文中的连续的 8 位子节对其进行后续的计算。只有字符中的 8 个数据位参与生成 CRC 的运算, 起始位, 停止位和校验位不参与 CRC 计算。The CRC calculations start with a 16 bit register with a full 1., and then follow the successive 8 bit section of the message for subsequent calculations. Only 8 data bits in the character are involved in generating CRC operations, starting bits, stop bits, and parity bits, and are not involved in CRC calculations.

生成 CRC 的过程为: The process of generating CRC is:

1. 将一个 16 位寄存器装入十六进制 FFFF (全 1)。将之称作 CRC 寄存器。
 1. load a 16 bit register into sixteen hexadecimal FFFF (full 1). This is called the CRC register
2. 将报文的第一个 8 位字节与 16 位 CRC 寄存器的低字节异或, 结果置于 CRC 寄存器。
 2. exclusive of the first 8 bit byte of the message with the low byte of the 16 bit CRC register, which is placed in the CRC register
3. 将 CRC 寄存器右移 1 位 (向 LSB 方向), MSB 充零。提取并检测 LSB。
 3. shift the CRC register to 1 bits (to the LSB direction), and MSB to zero. Extract and detect the LSB.
4. (如果 LSB 为 0): 重复步骤 3 (另一次移位)。
 4. (if LSB is 0): repeat step 3 (another shift)
 - (如果 LSB 为 1): 对 CRC 寄存器异或多项式值 0xA001 (1010 0000 0000 0001).
 - (if LSB is 1): XOR polynomial for the CRC register, 0xA001 (1010000000000001)
5. 重复步骤 3 和 4, 直到完成 8 次移位。当做完此操作后, 将完成对 8 位字节的完整操作。
 5. repeat steps 3 and 4 until the 8 shift is completed. When this is done, complete operation of the 8 bit byte is completed.
6. 对报文中的下一个字节重复步骤 2 到 5, 继续此操作直至所有报文被处理完毕。

6. repeat the steps 2 to 5 in the next byte of the message, continue this operation until all messages have been processed.

7. CRC 寄存器中的最终内容为 CRC 值。

7. The final content in the CRC register is the CRC value.

8. 当放置 CRC 值于报文时，高低字节必须交换。低位字节首先发送，然后是高位字节

8. when the CRC is placed on the message, the high and low byte must be exchanged. The low byte is sent first, followed by the high byte

例如：从站点号为 01 H 的驱动器读取 2 个字（word），读取起始地址为 0200 H 地址。从 Address 至数据的最后一位所计算出的 CRC 寄存器的最后内容为 0704 H，则其指令格式如下所示，注意，04H 在 07 H 的前面传送。

For example, read 2 words (word) from the drive with the site number 01 H and read the start address as 0200 H address. From the Address to the last bit of data, the final content of the calculated CRC register is 0704 H, and the instruction format is as follows. Note that the 04H is transmitted in front of 07 H.

Address		01H
CMD		03H
数据起始地址 Data start address	高位 High position	02H
	低位 low position	00H
数据长度(以 word 计算) Data length (calculated in word)		00H
		02H
CRC 低位 CRC low position		C5H
CRC 高位 CRC high position		B3H

CRC 生成范例：(CRC generation paradigm:)

下面以 C 语言产生 CRC 值。此函数需要两个参数：(CRC values are generated in the C language below. This function requires two arguments.)

unsigned char * data; //数据起始地址，用于计算 CRC 值(The data start address used to calculate the CRC value)

unsigned char length; //数据长度(Data length)

此函数将返回 unsigned integer 类型的 CRC 值。(This function returns the CRC value of the unsigned integer type.)

```
unsigned int crc_chk(unsigned char * data,unsigned char length)
```

```
{
    int i,j;
```

```

unsigned int crc_reg=0xFFFF;
While(length- -)
{
  Crc_reg ^=*data++;
  for(j=0;j<8;j++)
  {
    If(crc_reg & 0x01)
    {
      crc_reg=( crc_reg >>1)^0xA001;
    }else
    {
      crc_reg=crc_reg >>1;
    }
  }
}
return crc_reg;
}

```

7.3.6 异常码 Exception code

在通信过程中，可能会产生通信错误，常见错误事件如下表：Communication errors may occur during communications, and common error events are shown below:

通信错误事件 Communication error event	伺服驱动器应对方法 Servo driver response method
读写参数时，数据地址不正确；The data address is incorrect when you read and write arguments;	请求不作处理，并返回一个错误异常码 The request does not process and returns an error exception code
写参数时，写数据个数超过最大值或数据不在此参数的取值范围内；When writing a parameter, the number of data is written more than the maximum or the data is not within the range of the parameter;	请求不作处理，并返回一个错误异常码 The request does not process and returns an error exception code
数据传输错误或者校验码(LRC、CRC、奇偶检验)错误 Data transmission error or checksum code (LRC, CRC, parity check) error	数据被丢弃，不返回响应，上位机应将请求作为超时状态处理 The data is discarded and no response is returned. The host should treat the request as a timeout state

驱动器发送错误异常码时，将命令功能码加上80H后一起传送给ModBus 主站系统。若处于广播模式，则不返回异常码或数据。异常码如下表：When the drive sends an error exception code, the command function code is added to the 80H and sent to the ModBus master system. If it is in broadcast mode, no exception code or data is returned. The exception code is shown below:

01 H	伺服驱动器不能识别请求的功能码 The servo driver cannot recognize the requested function code
02 H	请求给出的数据地址非法The requested data address is illegal
03 H	请求给出的数据在伺服驱动器中不允许（读写数据个数超过驱动器允许最大值或写数据值不在参数的取值范围内）The requested data is not allowed in the servo drive (the number of read and write data exceeds the maximum allowable value of the drive or the write data value is not within the parameter range)
04 H	伺服驱动器已经在开始执行请求，但不能完成该请求。The servo drive is already executing the request, but it cannot complete the request.

7.4 伺服参数、状态信息通信地址 Servo parameter, status information, communication address

数据地址 Data address		含义 Meaning	说明 Explain	操作权限 Operation authority
十六进制 Hexadecimal	十进制 Decimal system			
0000H~00ECH	0 ~ 236	参数设置区 Parameter setting area	对应 Pn000~Pn236 Corresponding Pn000~Pn236	可读可写 Read-write
0164H~016DH	356 ~ 365	报警记录区 Alarm recording area	在 Fn000 中可以查看， 对应 Sn--0~Sn--9 In Fn000, you can view the corresponding Sn--0~Sn--9	只读 read-only
0170H~018CH	368 ~ 396	数据监控区 Data monitoring area	对应 Dn000~Dn028Correspon ding Dn000~Dn028	只读 write-only

第8章运行与调整

The eighth chapter, operation and adjustment

依照接线图，安装和连线完毕之后，在通电之前先检查以下几项：

According to the wiring diagram, after installation and connection, check the following items before power on:

▲电源端子接线是否正确、可靠输入电压是否正确？ Is the power supply terminal properly and reliable? Is the input voltage correct?

▲电源线、电机线有无短路或接地？ Is there any short circuit or earthing of the power line and motor line?

▲编码器电缆连接是否正确？ Is the encoder cable correct?

▲驱动单元和电机是否已固定牢固？ Are the drive units and motors firmly secured?

▲电机轴是否未连接负载？ Is the motor shaft connected to the load at the end?

▲制动电阻连接（选配）是否正确？ Is the brake resistance connection (optional) correct?

▲串口通信线（选配）是否连接正确？ Is the serial communication line (optional) properly connected?

8.1 点动运行 Inching operation

(1) 伺服使能 (SON) OFF。内部使能 (Pn003=0) 或外部接线控制使能处于 OFF 状态。建议 CN2 控制接口不接任何控制线。

(1) servo enable (SON) OFF. The internal enable (Pn003=0) or external wiring control enables the OFF to be in a state. It is recommended that the CN2 control interface do not receive any control lines.

(2) 接通电路电源，驱动器的5位数码管显示点亮，如果有报警出现，则5个小数点一直闪烁，且显示报警代码AL-xx。请检查连线。

(2) switch on the circuit power, drive 5 digital tube display light, if there is an alarm, then 5 decimal point has been flashing, and display alarm code AL-xx. Please check the connection.

(3) 确认没有报警和任何异常情况后，进入辅助模式 Fn002子目录JOG_0(具体操作与参数设置见第三章

3.4.4节Fn002试运行操作), 按住  键或  键进行正反转运行, 释放按键, 电机减速后, 不再通电。

(3) confirmed that no alarm and any abnormal situation, enter the auxiliary mode Fn002 subdirectory JOG_0 (specific operation and parameter settings see Chapter third section 3.4.4 Fn002 trial operation), hold the key to reversing operation, release button, motor reducer, no electricity.



8.2 按键调速运行 Push-button speed control

(1) 伺服使能 (SON) OFF。内部使能 (Pn003=0) 或外部接线控制使能处于 OFF 状态。建议 CN2 控制接口不接任何控制线。

(1) servo enable (SON) OFF. The internal enable (Pn003=0) or external wiring control enables the OFF to be in a state. It is recommended that the CN2 control interface do not receive any control lines.

(2) 接通电路电源, 驱动器的5位数码管显示点亮, 如果有报警出现, 则小数点一直闪烁, 且显示报警代码 AL-xx。请检查连线。

(2) switch on the circuit power, the driver of the 5 digital tube display light, and if there is an alarm, the decimal point has been flashing, and display alarm code AL-xx. Please check the connection.

(3) 确认没有报警和任何异常情况后, 进入辅助模式 Fn002子目录JOG_1(具体操作与参数设置见第三章 3.4.4节Fn002试运行操作)。进入JOG_1的下层目录后, 显示屏显示为0(单位: r/min) 且电机已通电, 通过按  键或  键, 输入电机将要运行的速度, 电机将按此速度运行。若要退出此操作, 需进行JOG_2操作。

(3) to confirm that no alarms and any exceptions have been entered into the auxiliary mode Fn002 subdirectory JOG_1 (specific operations and parameter settings, see Chapter third, section 3.4.4, Fn002, trial operation). After entering the lower directory of JOG_1, the display is shown as 0 (unit: r/min), and the motor has been energized. Through the key or key, the input motor will be running at speed, the motor will run at this speed. To exit this operation, you need to perform JOG_2 operations.

8.3 增益调谐 Gain tuning

增益调谐是通过调整伺服增益参数组合(转动惯量比、位置环增益、速度环比例增益、速度环积分时间、指令滤波器等)来优化伺服响应性能的功能。调整伺服增益时, 必须考虑各参数间的相互作用影响, 因此需平衡调整各增益参数值, 不可进行极端设置。Gain tuning is a function of optimizing servo response performance by adjusting servo gain parameter combination (inertia ratio, position loop gain, speed loop proportional gain, speed loop integration time, instruction filter, etc.). When servo gain is adjusted, the interaction between parameters must be taken into account, so it is necessary to balance the parameters of each gain and not to set extreme parameters.

一般情况下, 高刚性机械可通过提高伺服增益来提高响应性。而对于低刚性

机械，提高伺服增益反而可能会产生振动，带来负面作用。此时，可以通过降低刚性等级或伺服单元的各种振动抑制功能来抑制振动。In general, high stiffness machines can improve responsiveness by increasing servo gain. For low rigidity machines, the increase of servo gain may produce vibration and bring about negative effects. At this point, vibration can be suppressed by reducing the stiffness levels or various vibration suppression functions of the servo unit.

一般系统调试流程如下图所示：The general system debugging process is shown below:

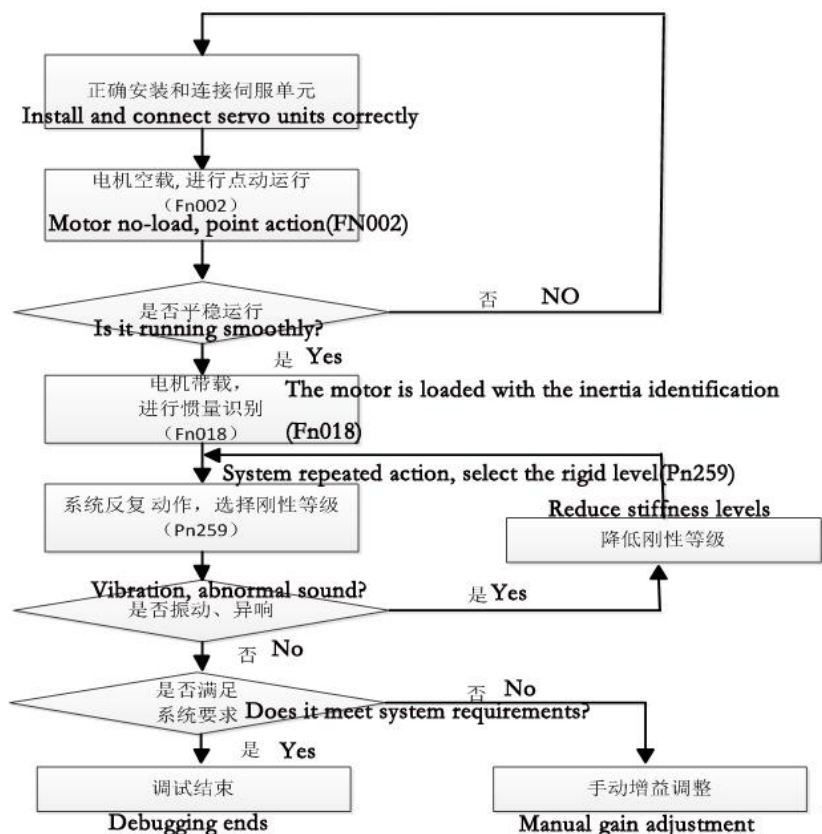

8.3.1 系统惯量识别 System inertia identification

自动调谐是指伺服在运行过程中识别负载转动惯量，以达机械刚性等级（Pn259）的设定要求。为达到较优的响应性能，必须进行惯量识别。Automatic tuning refers to the identification of the load inertia during the operation of the servo to achieve the mechanical rigidity grade (Pn259) setting requirements. In order to achieve better response performance, inertia identification must be carried out.

在下述情况下，可能不能有效的进行惯量推算：In the following cases, the inertia calculation may not be effective:

- 负载惯量变化快 Load inertia changes rapidly

- 机械刚性极低Mechanical rigidity is very low
- 机械部件连接不牢固，比如存在反向间隙The mechanical components are not firmly connected, for example, there is a reverse clearance
- 最高速度不足150转/分和连续低速使用Maximum speed of less than 150 rpm and continuous low speed use
- 加减速在1秒内2000转/分以下的和缓状态A slowing state of 2000 revolutions per minute in a second
- 负载刚性易于产生小幅度振动或摩擦较大Load rigidity is easy to produce small amplitude vibration or friction

惯量推定的相关参数: Related parameters of inertia estimation:

Pn257	负载转动惯量比 Load inertia ratio	0~100.00	1.00	倍 times
Pn263◆	惯量推定加减速时间 Inertia estimation acceleration and deceleration time	20~500	80	ms
Pn264◆	惯量推定允许最高速度 Inertia estimation allows maximum speed	150~1000	400	r/min
Pn265◆	惯量推定暂停时间间隔 Inertia estimation pause interval	0~10000	500	ms
Pn266◆	惯量推定惯量比预估值 Inertia estimation; inertia ratio; prediction value	1.00~20.00	3.00	倍 times

惯量推定的行程: $S=V*T=Pn264*(Pn263/60000)$ 。默认时, 最大近似行程 $S=400*80/60000=0.53$ 转 (2500线编码器)。The stroke of inertia estimation: $S=V*T=Pn264*(Pn263/60000)$. By default, the maximum approximation stroke is $S=400*80/60000=0.53$ turn (2500 line encoder).

开始离线惯量推定操作前, 必须进行以下设定: The following settings must be set before starting the offline inertia estimation operation:

- 主电源已接入。Main power is in.
- 伺服未使能。Servo not enabled.
- 安装限位开关, 使用正向驱动禁止(CCWL)、反向驱动禁止(CWL)功能, 防止机械超程引发事故。Install limit switches using forward drive inhibit (CCWL) and reverse drive inhibit (CWL) function, Prevent accidents caused by mechanical accidents.
- 各参数设定得当, 惯量推定的电机加减速时间和运行速度合适, 尽量避免平缓低速的运行状态。When the parameters are set properly, the motor acceleration and deceleration time and running speed are estimated by inertia, Try to avoid gentle and low speed running condition.

惯量识别的一般流程如下: The general flow of inertia identification is as follows:

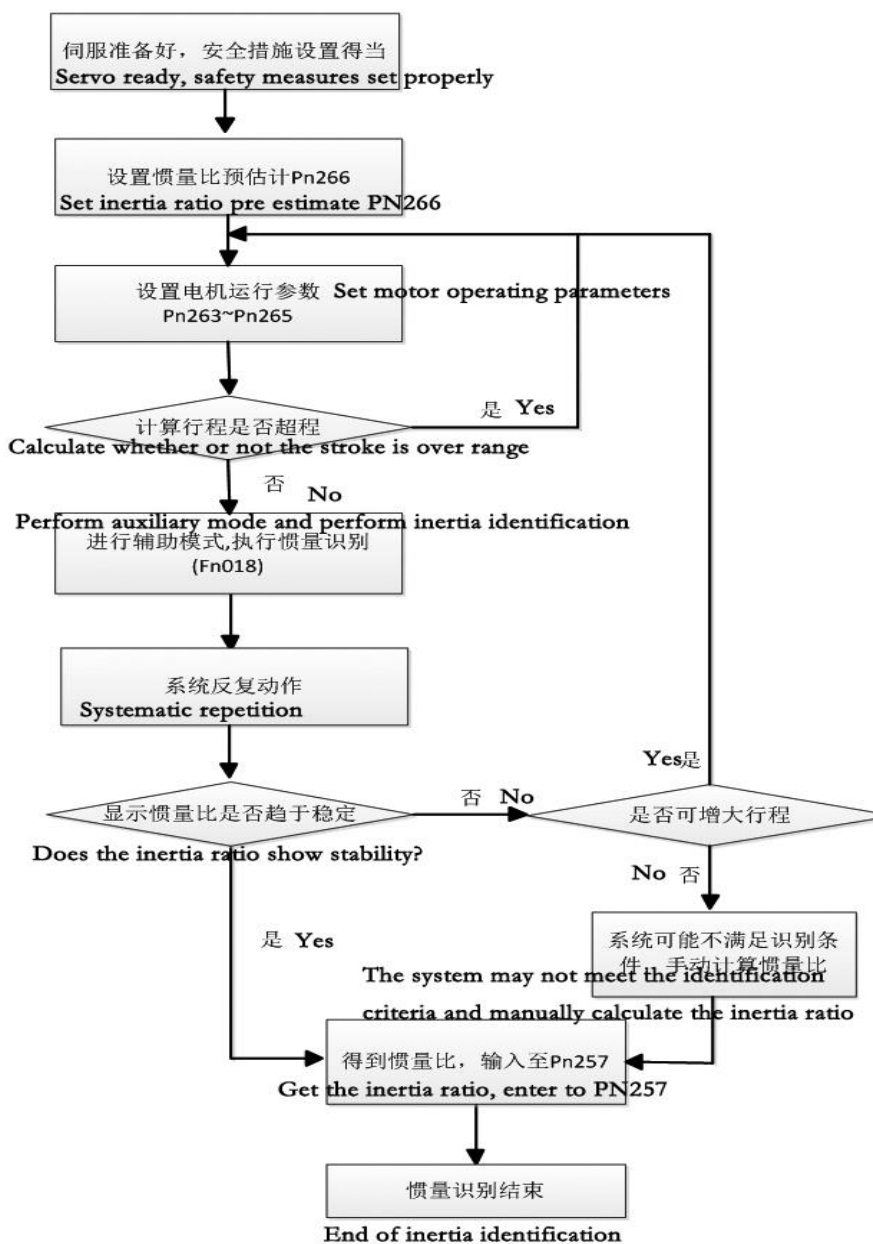

惯量识别流程图
Flow chart of inertia identification

8.3.2 自动增益调整 Automatic gain adjustment

自动增益调整时，机械刚性设定包括以下 21 种类型。在设置增益调整模式(Pn258)为 1 时，选择机械刚性等级(Pn259)，伺服将根据增益参数设定表自动选取伺服增益(位置环增益、速度环增益、速度环积分时间常数、扭矩指令滤波器滤波时间)。此时，Pn115、Pn116、Pn153~P156、Pn196、Pn197 等增益参数在自动增益调整模式下无效。

For automatic gain adjustment, the mechanical rigidity setting consists of the following 21 types. In setting the gain adjustment mode (Pn258) is 1, the mechanical rigidity level (Pn259), will be based on the servo gain parameter setting table to automatically select the servo gain (position loop gain, speed loop gain, speed loop integral time constant, torque command filter time). At this point, gain parameters such as Pn115, Pn116, Pn153~P156, Pn196, and Pn197 are not valid in automatic gain adjustment mode.

增益参数设定表如下: The gain parameter setting table is as follows:

机械刚性等级 Mechanical stiffness class Pn259	位置环增益 Position loop gain [1/s]	速度环增益 Speed loop gain [Hz]	速度环积分时间常 数Velocity loop integral time constant [0.1ms]	扭矩滤波时间 Torque filtering time [0.01ms]
0	10	10	550	220
1	15	15	500	180
2	20	20	450	150
3	30	30	300	110
4	40	40	200	60
5	50	50	160	45
6	60	60	150	40
7	85	85	100	35
8	115	115	95	30
9	120	120	91	25
10	130	140	85	22
11	150	160	60	20
12	180	200	50	15
13	195	220	40	12
14	210	250	35	10
15	230	270	30	10
16	250	300	29	10
17	270	350	27	10
18	330	400	22	10
19	380	450	19	10

20	450	500	17	10
----	-----	-----	----	----

增益调整时，若增大机械刚性设定值，伺服的响应会提高，定位的时间也会缩短。但是，过高的增益会导致机械振动。因此，请在不发生振动的情况下，从低刚性等级逐级往上调，同时增益必须留有裕量，避免出现临界状态。对于皮带轮等连接刚性低的负载设备，设定的刚性等级不能太高，而如滚珠丝杠等连接刚性高的负载设备，可以设定较高的刚性等级。When the gain is adjusted, if the mechanical rigidity setting value is increased, the response of the servo will be improved, and the positioning time will be shortened. However, excessive gains can cause mechanical vibrations. Therefore, in case of no vibration, increase from low stiffness to level up, and the gain must remain margin to avoid critical condition. For low load devices such as pulleys, the rigid level of the device cannot be too high, but a higher rigidity class can be set up, such as a ball screw, which is connected with a rigid load device.

增益调整一般流程图如下：The general flowchart of gain adjustment is as follows:

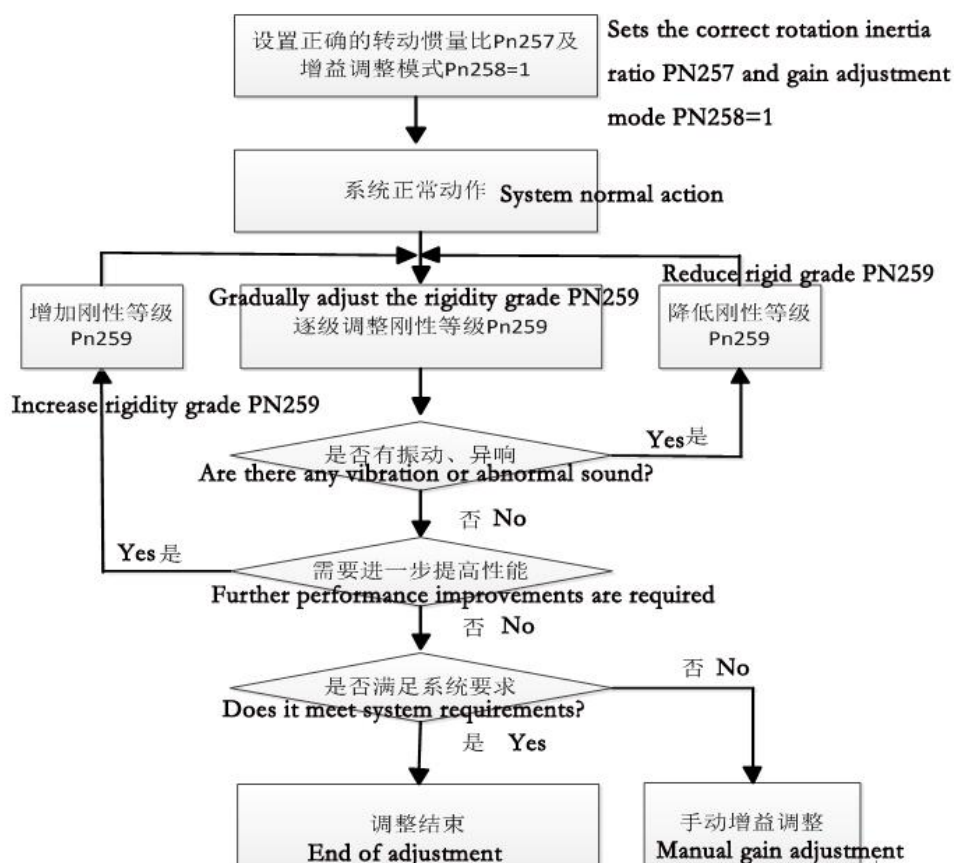

8.3.3 手动增益调整 Manual gain adjustment

进行手动增益调整时，设置 Pn258 为 0。通过以下伺服增益参数，调整伺服单元的响应特性。When manual gain adjustment is performed, set Pn258 to 0. The response characteristics of the servo unit are adjusted by the following servo gain parameters.

编号 NO.	名称 Name	取值范围 Range of values	默认值 Default value	单位 Unit	适用 Apply
Pn045	增益切换选择 Gain switching selection	0~5	0	-	All
Pn115	位置调节器增益 1 Position regulator gain 1	1~2000	100	1/S	P
Pn116	位置调节器增益 2 Position regulator gain 2	1~2000	100	1/S	P
Pn153	速度调节器比例增益 1 Speed regulator proportional gain 1	1~ 2000	80	Hz	All
Pn154	速度调节器积分时间常数 1 Speed regulator integration time constant 1	1~ 5000	150	0.1ms	All
Pn155	速度调节器比例增益 2 Speed regulator proportional gain 2	1~ 2000	80	Hz	All
Pn156	速度调节器积分时间常数 2 Speed regulator integration time constant 2	1~ 5000	150	0.1ms	All
Pn196▲	转矩指令滤波时间常数 1 Torque instruction filtering time constant 1	1~5000	40	0.01m s	All
Pn197▲	转矩指令滤波时间常数 2 Torque instruction filtering time constant 2	1~5000	40	0.01m s	All

手动增益调整一般流程如下：Manual gain adjustment general process is as follows:

步骤 step	内容 Content
1	正确设定转动惯量比 Pn257。设置 Pn258 为 0。Correct setting of inertia ratio Pn257. Set Pn258 to 0.
2	在机械不产生振动的情况下，尽可能提高速度环增益(Pn153,Pn155)，减小速度环积分时间常数(Pn154,Pn156)。As long as the machine does not generate vibration, the speed ring gain (Pn153,Pn155) is increased as much as possible, and the speed loop integration time constant (Pn154, Pn156) is reduced.
3	调整转矩指令滤波器时间参数(Pn196,Pn197),并置于不产生振动的设定值。Adjust the torque instruction filter time parameter (Pn196, Pn197) and place the setpoint that does not generate

	vibration.
4	重复 2 和 3 步骤，在满足系统要求的情况下，适当减小速度环增益，增加速度环的积分时间常数,留出裕量。Repeat the 2 and 3 steps. In the case of meeting the system requirements, reduce the speed ring gain properly, increase the integral time constant of the speed ring, and leave the margin.
5	位置控制时，在机械不产生振动的范围内逐步提高位置环增益 (Pn115,Pn116)。The position loop gain (Pn115, Pn116) is gradually increased in the range of no vibration when the position is controlled.

注 1: 默认情况下, Pn045=0, 第一组增益有效, 可不必同时设置两组增益。Note 1: by default, Pn045=0, the first set of gains is valid, and there is no need to set two sets at the same time.

注 2: 可适当参考增益参数设定表, 在此基础上进行参数微调。Note 2: parameter tuning can be carried out on the basis of proper reference to the gain parameter setting table.

8.3.4 抑制抖动方法 Jitter suppression method

当伺服增益过高时, 可能会出现电机轴抖动现象。为避免出现抖动, 可按如下方法处理: When servo gain is too high, motor spindle wobble may occur. To avoid jitter, you can do as follows:

- 位置控制时, 当定位完成后, 适当降低伺服增益, 使用振动抑制衰减功能参数 (Pn139~Pn141)。When the position is complete, the servo gain is reduced properly and the vibration suppression function parameter (Pn139~Pn141) is used.
- 设置正确的负载惯量比。对于大惯性负载或高刚性、快响应设备, 太小的速度环时间积分常数易造成定位过冲或摆动。Set the correct load inertia ratio. For large inertia load or high rigidity and fast response device, too small speed loop time integration constant is easy to cause positioning overshoot or swing.
- 使用增益切换功能(附录 A), 降低抖动频段的增益。Using the gain switching function (Appendix A), the jitter band gain is reduced.
- 适当增加转矩指令滤波器时间参数 (Pn196, Pn197)。Appropriately increase the torque instruction filter time parameter (Pn196, Pn197).
- 调节速度反馈补偿 (Pn183)。速度反馈补偿量越大, 响应变快, 但电机噪音越响。Regulation speed feedback compensation (Pn183). The greater the speed feedback compensation, the faster the response, but the more noise the motor.

第 9 章 伺服单元控制结构与实例

The ninth chapter, servo unit control structure and example

9.1 位置控制实例 Position control example

9.1.1 位置控制结构图 Position control structure diagram

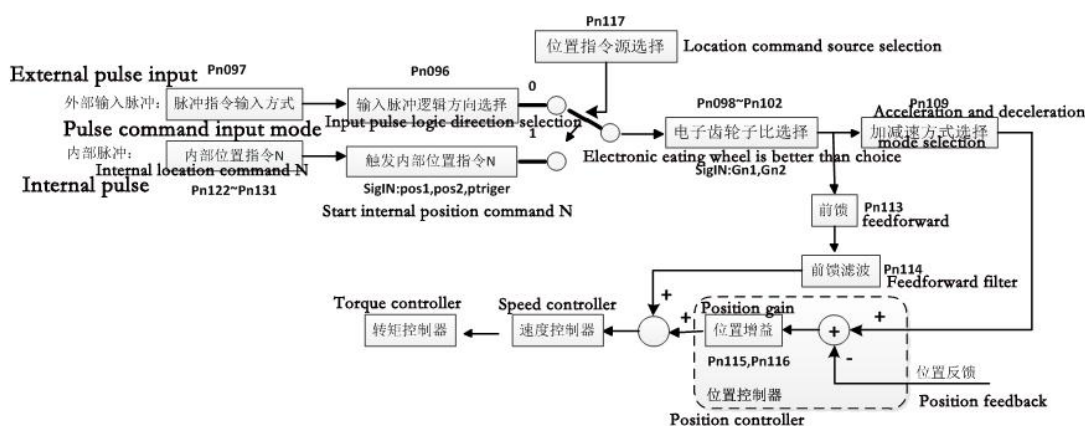

9.1.2 位置控制举例 Example of position control

外部以脉冲方向的形式输入 20K 频率的正方向脉冲，发送的个数 1.5 万个，电子齿轮比 3:1，加减速时间 60ms。则需设置的参数：External pulse direction in the form of input 20K frequency of the positive pulse, the number of transmission 15 thousand, electronic gear ratio 3:1, plus and deceleration time 60ms. The parameters you need to set:

Pn097=0,Pn096=0,Pn117=0,Pn098=3,Pn109=1,Pn110=60。

若不采用外部端口使能电机，可设置 Pn003=1，内部自动使能电机。当外部输入脉冲后，电机逆时针旋转 4.5 圈(2500 线编码器)。If an external port enable motor is not used, the Pn003=1 can be set internally with an automatic enable motor. When the external input pulse, the motor counter clockwise rotation 4.5 times (2500 line encoder).

9.2 速度控制实例 Example of speed control

9.2.1 速度控制结构图 Speed control structure diagram

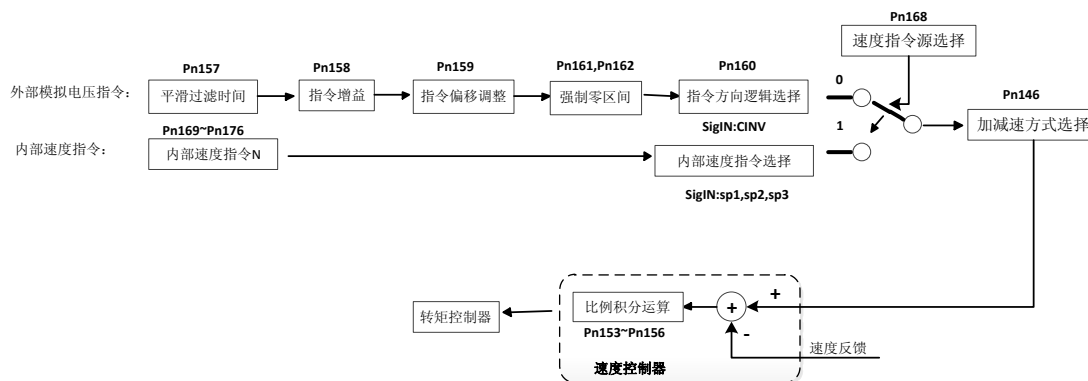

9.2.2 速度控制举例 Example of speed control

采用内部速度控制，驱动器内部使能，电机顺时针旋转，速度为 600rpm,采用 s 曲线加减速， $T_s=10ms, T_a=30ms, T_d=100ms$ 。

Adopt internal speed control, drive internal enable, motor clockwise rotation, speed of 600rpm, using S curve acceleration and deceleration, $T_s=10ms, T_a=30ms, T_d=100ms$.

需设置的参数：Parameters to set:

$Pn002=1, Pn003=1, Pn146=1, Pn147=10, Pn148=30, Pn149=100, Pn168=1, Pn169=-600$ 。

9.3 转矩控制实例 Torque control example

9.3.1 转矩控制结构图 Torque control structure diagram

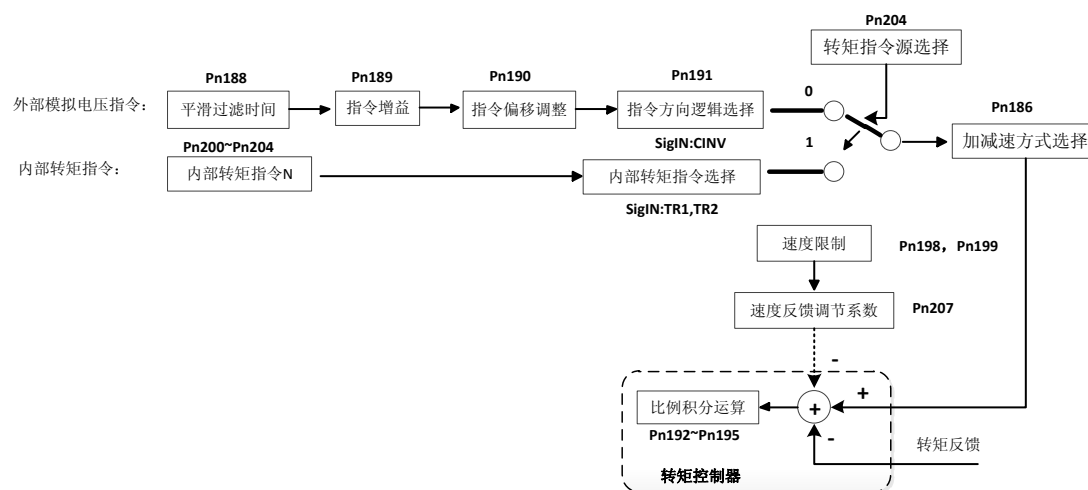

9.3.2 转矩控制举例 Example of torque control

外部模拟电压输出 0.5V, 转矩达到额定转矩的 15%, 电机轻载时最高转速限制为 1800rpm, 加减速时间为 500ms, 内部自动使能工作。The external analog voltage output 0.5V, torque reached 15% of the rated torque, when the motor is light load, the maximum speed limit is 1800rpm, the acceleration and deceleration time is 500ms, the internal automatic enable work.

设置参数如下: Set parameters as follows:

Pn002=0, Pn003=1, Pn186=1, Pn187=500, Pn198=1800, Pn204=0。

注: 空载、轻载情况下, 实际转矩达不到输入的转矩指令, 电机以最高限制速度运行。
Note: under the condition of no load or light load, the actual torque can not reach the input torque command, and the motor runs at the highest limit speed.

9.4 电子齿轮比计算 Electronic gear ratio calculation

电子齿轮功能是对1个输入脉冲指令的工件移动量进行缩放的功能。1个输入脉冲指令也称做“1指令单位”。通过电子齿轮比调整, 指令控制器”可以不顾及机器的减速比或编码器的线数来进行控制。An electronic gear function is a function of the amount of movement of 1 input pulse instructions. The 1 input pulse command is also called the 1 instruction unit”. Through the adjustment of the electronic gear ratio, the instruction controller can be controlled without regard to the reduction ratio of the machine or the number of lines of the encoder.

1 确定机器规格 Determine machine specifications

与电子齿轮相关的要素如下所示: The elements associated with the electronic gear are as follows:

- 减速比Reduction ratio
- 滚珠丝杠节距Ball screw pitch
- 皮带轮直径等 Pulley diameter, etc.

Ball screw pitch

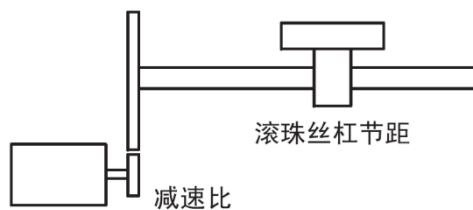

Reduction ratio

2 伺服电机编码器脉冲数 Servo motor encoder pulse number

编码器类型 Speed fbk sel	单圈脉冲数 Single loop pulse number
增量式编码器 Incremental encoder	10000
17 位绝对式编码器 17 bit absolute encoder	131072

3 决定指令单位 Decision instruction unit

指令单位是指指负载移动位置信息的最小单位。应考虑机器规格、定位精度等因素决定指令单位。常用的物理单位可作为最小指令单位，如 0.01mm, 0.001mm, 0.1° 等。The instruction unit is the smallest unit indicating the moving position information of the load. The unit of instruction should be considered in terms of machine specifications and positioning accuracy. Commonly used physical units can be used as the smallest instruction units, such as 0.01mm, 0.001mm, 0.1 degrees, etc..

4 根据指令单位, 求出负载轴旋转 1 圈的负载移动量。According to the instruction unit, the amount of load movement in the 1 turns of the load shaft is calculated.

负载轴旋转 1 圈的负载移动量(指令单位) = $\frac{\text{负载轴旋转 1 圈的负载移动量}}{\text{指令单位}}$ Load shaft rotates 1 cycles of load

movement (instruction unit) = load axis rotates 1 cycles of load movement / instruction unit

例: 滚珠丝杠节距 6mm, 指令单位 0.001mm 时, $\frac{6}{0.001} = 6000$ (指令单位)。

Example: ball screw pitch 6mm, instruction unit 0.001mm, $6/0.001=6000$ (instruction unit).

ball screw

circular truncated cone

Belt + pulley

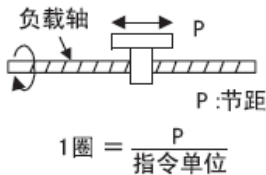
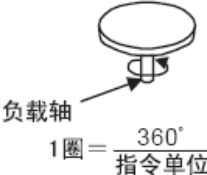
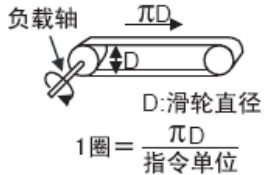
滚珠丝杠	圆台	皮带 + 皮带轮
 <p>负载轴</p> <p>P: 节距</p> <p>1圈 = $\frac{P}{\text{指令单位}}$</p>	 <p>负载轴</p> <p>1圈 = $\frac{360^\circ}{\text{指令单位}}$</p>	 <p>负载轴</p> <p>D: 滑轮直径</p> <p>1圈 = $\frac{\pi D}{\text{指令单位}}$</p>

5 求出电子齿轮比。Find out the ratio of the electronic gear.

假定电机轴和负载轴的减速比设为 $(\frac{m}{n})$, 即伺服电机旋转 m 圈, 负载轴旋转 n。

It is assumed that the reduction ratio of the motor shaft and the load shaft is (m/n) , that is, the servo motor rotates m circle and the load shaft rotates n.

电子齿轮比 = $\frac{\text{编码器单圈脉冲数}}{\text{负载轴旋转 1 圈的负载移动量(指令单位)}} \times \frac{m}{n}$ Electronic gear ratio = number of pulses per unit of rotation / (load shaft rotation, 1 turns of load movement (instruction units)) $\times m/n$

6 设定参数 Setting parameters

将电子齿轮比约分之后, 设为用户参数。After dividing the electronic gear, it is set as user parameter.

电子齿轮比 (约分后) $\frac{Pn098}{Pn102}$ Electronic gear ratio (after reduction) = $Pn098/Pn102$

9.5 电子齿轮比举例 Example of electronic gear ratio

9.5.1 滚珠丝杆 ball screw

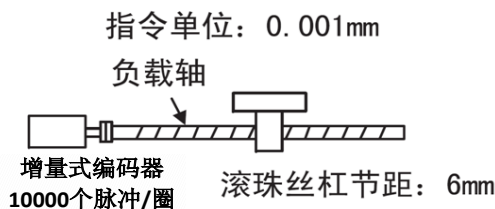

负载轴旋转 1 圈的负载移动量(指令单位)=6mm/0.001mm=6000

Load shaft rotates 1 cycles of load movement (instruction unit) =6mm/0.001mm=6000

电子齿轮比=10000/6000=5/3。 Electronic gear ratio =10000/6000=5/3.

设定 Pn098=5, Pn102=3。 Set Pn098=5, Pn102=3.

9.5.2 圆台 circular truncated cone

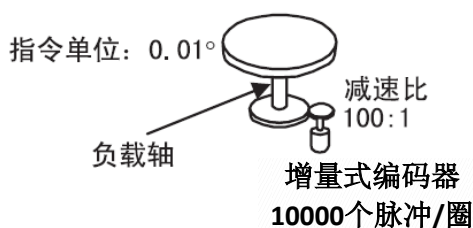

负载轴旋转 1 圈的负载移动量(指令单位)= $360^\circ / 0.01^\circ = 36000$ 。 Load shaft rotates 1 cycles of load movement (instruction unit) =360 degrees /0.01 degrees =36000.

电子齿轮比=10000/36000*100=250/9。 Electronic gear ratio =10000/36000*100=250/9.

设定 Pn098=250, Pn102=6。 Set Pn098=250, Pn102=6.

9.5.3 皮带+皮带轮 Belt + pulley

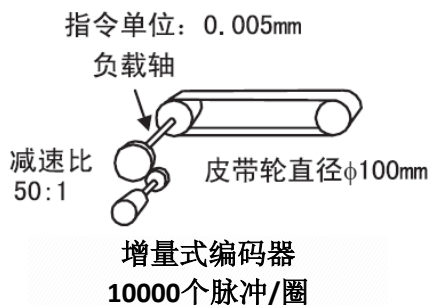

负载轴旋转 1 圈的负载移动量(指令单位)= $3.14 \times 100 / 0.005 = 62800$ 。

Load shaft rotates 1 cycles of load movement (instruction unit) = $3.14 \times 100 / 0.005 = 62800$.

电子齿轮比=10000/62800*50=1250/157。 Electronic gear ratio =10000/62800*50=1250/157.

设定 Pn098=1250, Pn102=157。 Set Pn098=1250, Pn102=157.

第 10 章绝对式伺服单元的使用

The tenth chapter, the use of absolute servo unit

10.1 绝对数据信息输出方式 Absolute data output mode

在伺服未使能时，上位机可通过端口信号 SigIn:Sen 信号，请求读取编码器的单圈多圈数据信息。读取时序如下：Can not wait on the can, the computer can through the port SigIn:Sen signal, request to read encoder single loop multi ring data information. Read the following sequence:

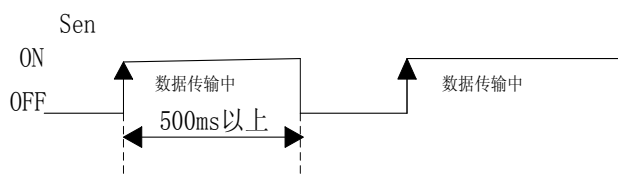

● 读取单圈、多圈数据时，请勿旋转电机。

Please do not rotate the motor when you read single or multi coil data.

● 在编码器通信没有故障情况下，将输出正常的的数据，否则不作响应。

In the absence of malfunction of encoder communications, normal data will be output, otherwise no response will be made.

● 在伺服发送编码器数据信息期间，若 Sen 信号再次由 OFF 变为 ON，将不作响应，直至数据发送完成。During the servo transmission encoder data, if the Sen signal is changed from OFF to ON again, the response will not be made until the data transmission is complete.

● 在伺服发送编码器数据信息期间，若伺服使能信号 son 或内部使能有效，将不作响应，直至数据发送完成。During servo sending encoder data information, if the servo enable signal son or internal enable is valid, it will not respond until the data transmission is complete.

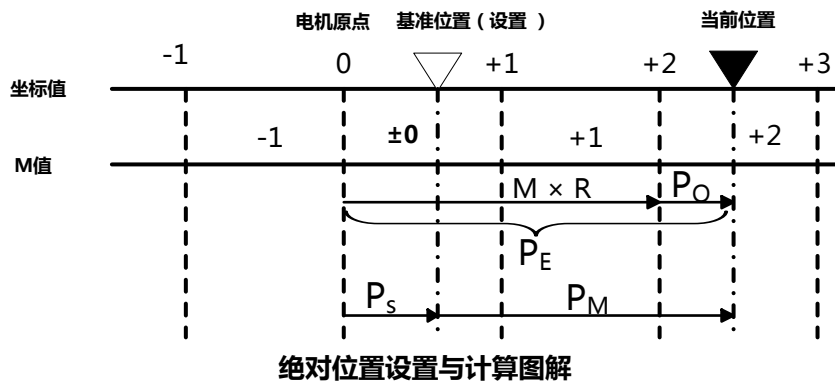

最终的绝对值数据 PM 根据下式求出: The final absolute value data, PM, is derived from the following formula:

$$PE = M \times R + PO$$

$$PM = PE - PS$$

其中: Among them:

PE: 从编码器读取的当前值 PE: the current value read from the encoder

M: 多圈旋转量数据 M: multi turn volume data

R: 编码器旋转1圈的脉冲数(分频后的值)

R: encoder rotates the number of pulses in 1 turns (values after frequency division)

PO: 初始增量脉冲数(单圈内的绝对位置)

PO: the number of initial increments (absolute position within a single loop)

PS: 基准位置相对电机原点的偏移值, 该初始增量值由上位机保存和管理

PS: the offset of the reference position relative to the origin of the motor. The initial increment is saved and managed by the host computer

PM: 用户需要的相对于基准位置的当前位置值

PM: the current position value that a user needs relative to the base position

10.2 绝对数据信息收发时序 Absolute data transceiver timing

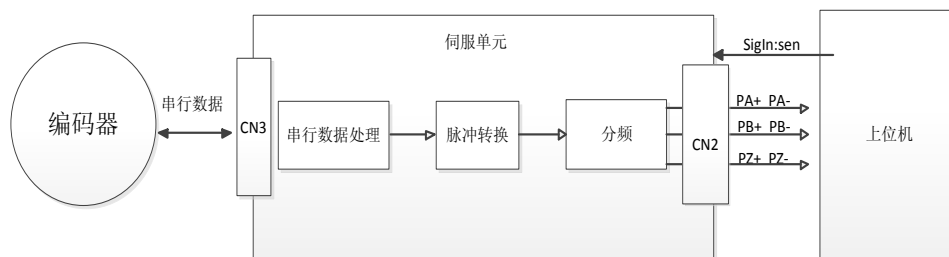

绝对式伺服单元数据信息收发框架图

Absolute servo unit data information transceiver frame

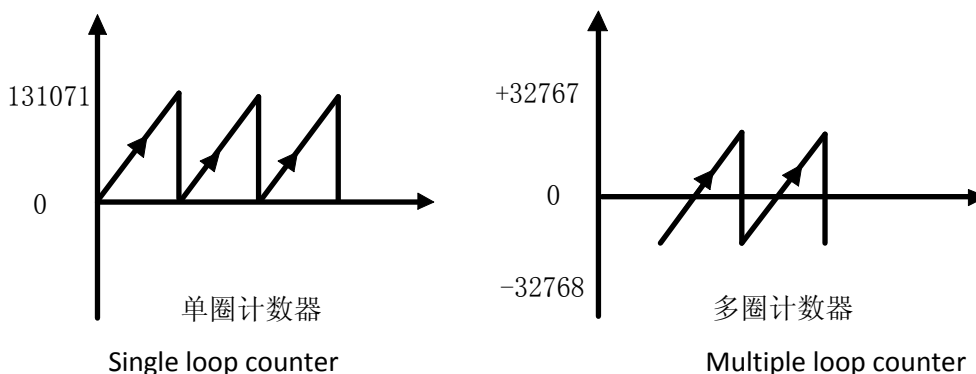

伺服电机 servo motor	单圈数据 输出范围 Single loop data output range	多圈数据 输出范围 Multi loop data output range	超限时操作 Over time operation
配有 17 位绝对式编码器 It is equipped with 17 bit absolute encoder	0~131071	-32768 ~+32767	多圈数据高于正转方向上限值 (+32767) 时：多圈数据 = -32768 Multi ring data is higher than the forward direction limit value (+32767): multi loop data = -32768 多圈数据低于反转方向下限值 (-32768) 时：多圈数据 = +32767 Multi ring data is lower than the reverse direction limit value (-32768); multi loop data = +32767

Pn218=0 时，增量方式发送单圈、多圈绝对位置数据信息。建议多次读取，以获取正确的绝对位置。
When Pn218=0, incremental send single circle and multi circle absolute position data information.
It is recommended to read multiple times to get the correct absolute position.

信号名 Signal name	状态 state	信号内容 Signal content
PA+ PA-	收发态 Transceiver state	初始增量型脉冲 Initial increment pulse
	通常态 Normal state	增量脉冲 Delta pulse
PB+ PB-	收发态 Transceiver state	初始增量型脉冲 Initial increment pulse
	通常态 Normal state	增量脉冲 Delta pulse
PZ+ PZ-	收发态 Transceiver state	低电平 Low level
	通常态 Normal state	原点脉冲 Origin pulse

单圈增量型脉冲是相当于以 1500r/min 的转速从电机轴原点位置开始旋转到当前电机轴位置时的分频脉冲速度所输出的脉冲。和通常的增量型脉冲一样，单圈位置脉冲是经过伺服单元内部的分频器分频后输出的。多圈增量脉冲的个数代表多圈位置数据，是没有经过分频器输出的。例：在多圈增量脉冲期间内，接收的脉冲个数+300 个，则代表电机轴位置在第 300 圈。

A single loop increment pulse is a pulse equal to the pulse speed at which the 1500r/min frequency rotates from the origin position of the motor shaft to the position of the current motor shaft. Like the usual incremental pulse, the single loop position pulse is output by frequency divider inside the servo unit. The number of multi loop pulse increments represents the multi ring position data, which is not output by the divider. Example: in a multi loop increment pulse, the number of pulses received is +300, representing the motor axis in the 300th loop.

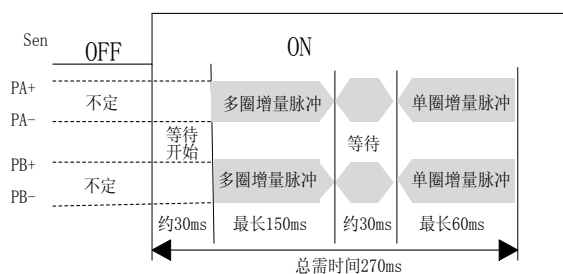

初始增量型脉冲发送时序

由于多圈数据的范围-32768~32767，当多圈数据为正时，电机逆时针(ccw)旋转；为负时，电机顺时针(cw)旋转。默认情况下，多圈数据为正值时，PA超前PB时，反之PA滞后PB。单圈数据的范围为0~131071，PA超前PB。Due to the range of multi loop data -32768~32767, when the multi ring data is positive, the motor rotates counterclockwise (CCW); when it is negative, the motor rotates clockwise (CW). By default, when the multi loop data is positive, the PA advances PB, whereas the PA lags PB. The range of the single loop data is 0~131071, and the PA is advanced PB.

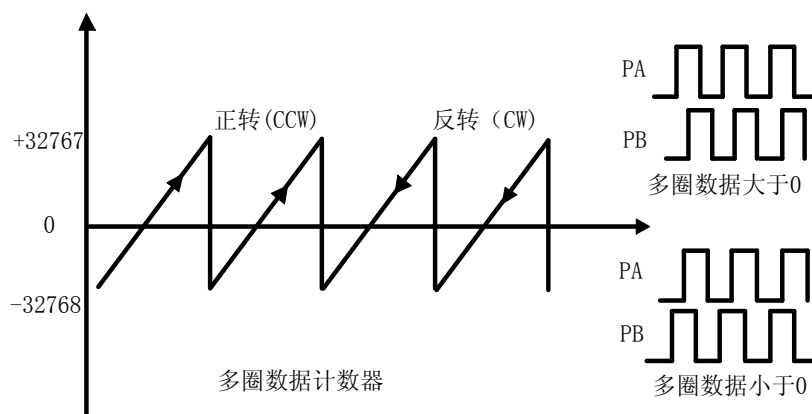

注：若 Pn018 编码器 AB 相位逻辑取反参数设置为 1，则 PA, PB 相位取反，多圈数据符号将取反。

Note: if the Pn018 encoder AB phase logic takes the inverse parameter set to 1, then the PA and PB phases are reversed, and the multi loop data symbols are inverted.

Pn218=1 时，以脉冲数字编码形式发送单圈、多圈绝对位置数据信息。建议多次读取，以获取正确的绝对位置。Pn218=1 sends single loop and multi circle absolute position data in the form of pulse digital encoding. It is recommended to read multiple times to get the correct absolute position.

信号名 Signal name	状态 state	信号内容 Signal content
PA+ PA-	收发态 Transceiver state	数字编码型增量脉冲 Digitally coded delta pulse
	通常态 Normal state	增量脉冲 Delta pulse
PB+ PB-	收发态 Transceiver state	数字编码型增量脉冲 Digitally coded delta pulse
	通常态 Normal state	增量脉冲 Delta pulse
PZ+ PZ-	收发态 Transceiver state	低电平 Low level
	通常态 Normal state	原点脉冲 Origin pulse

数字编码型增量脉冲:每隔约30ms，伺服将发送若干个脉冲，脉冲的个数将视为十六进制数字 (0~15->0~F)。Digital coded delta pulse: at about 30ms, the servo will send several pulses, and the number of pulses will be considered a sixteen digit number (0~15->0~F).

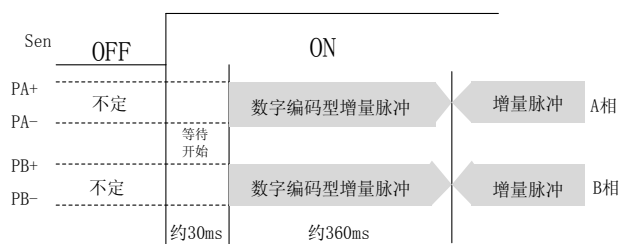

数字编码型增量脉冲发送时序

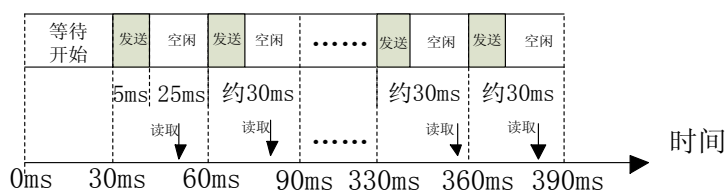

数字编码型增量脉冲帧格式

N1~N4	N5~N8	N9~N12
16位多圈数据（有符号整数）16 bit, multi ring data (signed integer)	16位单圈数据（无符号整数）16 bit single loop data (unsigned integer)	16位CRC校验码（无符号整数）16 bit CRC checksum (unsigned integer)

发送脉冲时，每次发送的脉冲增量在0~15之内，5ms之内发送完成。自上位机Sen信号由off变on时，开始计时，考虑到存在固定的几毫秒响应延迟，上位机须选择恰当的时间点，读取脉冲变化的个数（十六进制）。例如，在30ms时，伺服发送3个脉冲，上位机可在50ms时读取脉冲增量，个数为3则代表数字3。读取之后，等待几十毫秒，在80ms时读取第二个脉冲增量，依次类推。When sending a pulse, the pulse increments for each send are sent within 0~15 and completed within 5ms. When the Sen signal of the host computer is changed from off to on, the timing is started. Considering the fixed response delay of a few milliseconds, the upper computer must select the appropriate time point to read the number of pulse changes (sixteen hex). For example, in 30ms, the servo sends 3 pulses, and the upper computer can read the pulse increments at 50ms, with the number of 3 representing the number 3. After reading, wait for tens of milliseconds, in the 80ms read second pulse increments, and so on, and so on.

例：For example

次序	N1	N2	N3	N4	N5	N6	N7	N8	N9	N10	N11	N12
脉冲个数 Pulse number	0	3	14	8	1	0	10	5	4	13	14	15
	高位 0x03 High 0x03		低位 0xe8 Low 0xe8		高位 0x10 High 0x10		低位 0xA5Low 0xA5		CRC 低位 0x4D CRC low 0x4D		CRC 高位 0xEF CRC high 0xEF	
结 果	多圈数据：03e8H=+1000				单圈数据：10A5H=4261				CRC:EF4DH			

Result	Multi circle data: 03e8H=+1000	Single loop data: 10A5H=4261	
--------	-----------------------------------	---------------------------------	--

数据帧(8bits) Data frame (8bits)	03H	E8H	10H	A5H	4DH	EFH
-------------------------------	-----	-----	-----	-----	-----	-----

其中:CRC多项式采用modbus协议中的多项式: 0xA001, 其算法和代码已在第七章modbus通信功能中详细罗列。Among them: CRC polynomial using Modbus protocol polynomial: 0xA001, its algorithm and code have been detailed in the seventh chapter Modbus communication function.

此外, 上位机也可使用modbus串口通信方式读取绝对位置信息(Dn025~Dn028)。

In addition, the host computer can also read the absolute position information (Dn025~Dn028) by using MODBUS serial communication.

10.3ABZ 脉冲信号分频输出 ABZ pulse frequency division output

●通过设置 Pn018 参数, 可改变 AB 脉冲信号的相位关系。By setting the Pn018 parameter, the phase relation of the AB pulse signal can be changed.

Pn018	正转(ccw)	反转(cw)
0		
1		

●通过设置 Pn217 参数, 可改变每转输出的脉冲个数。By setting the Pn217 parameter, the number of pulses per turn output can be changed.

●Z 脉冲的相位关系 Phase relation of Z pulse

Z 信号与 A 或 B 信号边沿对齐, 持续 4 个脉冲时间。The Z signal is aligned with the edge of the A or B signal and lasts 4 pulses of time.

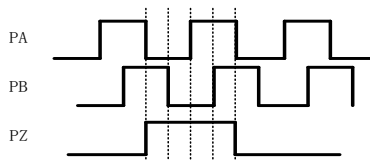

10.4 绝对式编码器的初始化 Initialization of absolute encoder

当有以下情况时，必须通过 Fn015 操作对绝对式编码器进行初始化：

When the following happens, the absolute encoder must be initialized by the Fn015 operation:

- 最初启动机械设备 Initially start the mechanical equipment
- 发生编码器电池低压报警 Encoder battery low voltage alarm
- 发生编码器内部故障报警 Internal fault alarm of encoder occurs
- 要将绝对式编码器的多圈数据设为 0 To set the absolute encoder's multi circle data to 0

当发生绝对式编码器报警时，而又不需复位多圈数据信息时，可执行 Fn016 操作，清除编码器上的报警。

When the absolute encoder alarm, and without the need to reset the multi ring data information, Fn016 operations can be carried out to remove the alarm on the encoder.

10.5 绝对式编码器电池的安装

Installation of absolute encoder batteries

当Pn216设置为1，绝对式编码器作多圈使用，为了保存绝对式编码器的位置数据，需要安装电池单元。请将电池单元安装在上位装置或伺服单元这两者任意一侧。请勿在上位装置和伺服单元两侧设置电池单元。如果同时在两侧设置，电池之间则会形成回路，非常危险。电池必须在3.2V~4.5V之间，过高电压会损坏编码器，过低电压会产生低压报警。一般情况下，请用3.6V 2000amH的锂电池。When the Pn216 is set to 1, the absolute encoder is used in many circles. In order to save the position data of the absolute encoder, the battery unit needs to be installed. Install the battery unit on either side of the upper or servo unit. Please do not set up the battery unit on the upper and servo units. If the battery is set on both sides at the same time, the circuit will be formed, which is very dangerous. The battery must be between 3.2V~4.5V, the high voltage will damage the encoder, and the low voltage will produce a low voltage alarm. In general, please use 3.6V 2000amH lithium battery.

更换电池前，只需接通电源即可。请勿使能驱动器，使电机处于工作状态。若在伺服单元的控制电源 OFF 后拆下电池（包括拆下编码器电缆时），所设定的绝对值编码器数据将会丢失，此时，需执行Fn015操作，复位多圈数据信息。Before you replace the battery, just switch on the power. Do not enable the motor to operate. If you remove the battery in the power control OFF servo unit (including after remove the encoder cable), the absolute value of the encoder data will be lost, at this time, to carry out the Fn015 operation, reset multi ring data information.

更换电池时，请注意电池的极性，和驱动器的接插接序号。若极性接反，将损坏编码器。When replacing the battery, please pay attention to the polarity of the battery and the serial number of the driver. If polarity is reversed, the encoder will be damaged.

更换好电池后，若驱动器有编码器报警产生，请执行Fn016操作，复位编码器报警信息，再重新上电驱动器。After replacing the battery, if the drive has an encoder alarm, please perform the Fn016 operation, reset the encoder alarm information, and then switch on the power drive again.

附录 appendix

附录 A 增益切换 Appendix A gain switching

第一增益 First gain		第二增益 Second gain	
参数 parameter	名称 Name	参数 parameter	名称 Name
Pn153	速度调节器比例增益 1 Speed regulator proportional gain 1	Pn155	速度调节器比例增益 2 Speed regulator proportional gain 2
Pn154	速度调节器积分时间常数 1 Speed regulator integration time constant 1	Pn156	速度调节器积分时间常数 2 Speed regulator integration time constant 2
Pn192	转矩 Q 轴调节器比例增益 1 Torque Q shaft regulator proportional gain 1	Pn194	转矩 Q 轴调节器比例增益 2 Torque Q shaft regulator proportional gain 2
Pn193	转矩 Q 轴调节器积分时间常数 1 Torque Q axis regulator integration time constant 1	Pn195	转矩 Q 轴调节器积分时间常数 2 Torque Q axis regulator integration time constant 2
Pn196	转矩 Q 轴滤波时间常数 1 Torque Q axis filter time constant 1	Pn197	转矩 Q 滤波时间常数 2 Torque Q axis filter time constant 2
Pn115	位置调节器增益 1 Position regulator gain 1	Pn116	位置调节器增益 2 Position regulator gain 2

注：增益切换时，必须处于合适的控制模式，设置参数 Pn0465、Pn046 的条件合适，才能满足增益切换条件，进行切换。Note: when the gain is switched, it must be in the proper control mode, and the condition of setting parameters Pn0465 and Pn046 is appropriate to satisfy the gain switching condition and switch.

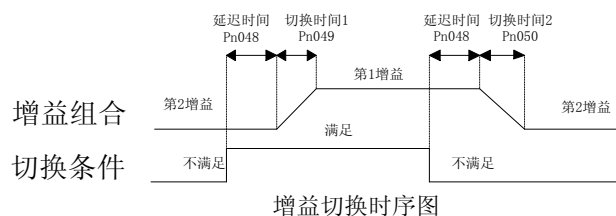

附录 B 控制模式切换 Appendix B control mode switching

B.1 位置/速度控制模式切换 Position / speed control mode switching

使用控制切换(cmode), 可通过输入控制端口SigIn接点进行位置控制模式和速度控制模式的切换。Using the control switch (Cmode), the position control mode and the speed control mode can be switched by inputting the control port SigIn contact.

cmode和控制模式的关系如下所示。The relationship between the Cmode and the control mode is as follows.

Cmode	控制模式control mode
OFF	位置控制模式Position control mode
ON	速度控制模式Speed control mode

可以在零速度状态时进行控制模式的切换。但为了安全起见, 请在伺服电机停止时进行切换。从位置控制模式切换到速度控制模式时, 滞留脉冲将被清除。电机使能前, 请先确定要进入的控制模式 (cmode引脚的状态)。电机使能时, 切换方式有两种, 时序图如下所示: The control mode can be switched at zero speed state. But to be on the safe side, switch on when the servo motor is stopped. When the position control mode is switched to speed control mode, the hold pulse will be cleared. Before enabling the motor, please determine the control mode to be entered (the status of the Cmode pin). There are two modes of switching when the motor is enabled. The timing diagram is as follows:

▲Pn132=0:

只有零速度状态下, 切换信号发生改变, 模式切换才有效; 如果不在零速度状态下, 切换信号发生了改变, 随后信号进入零速度状态, 则不发生模式切换。Only the zero speed state, switching signal change, mode switching is effective; if not in the zero velocity state, changed switching signal, then the signal into the zero velocity state, not mode switching.

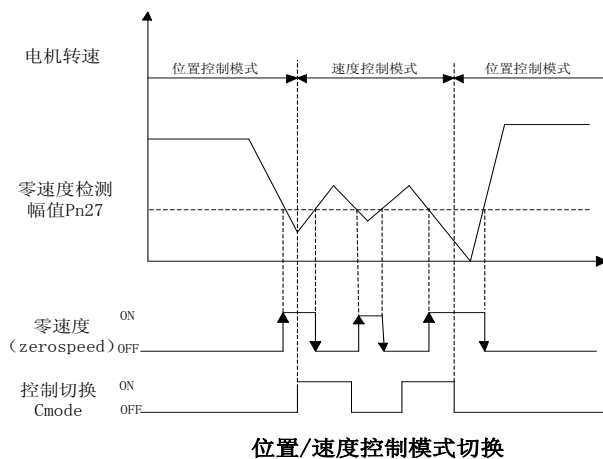

▲Pn132=1:

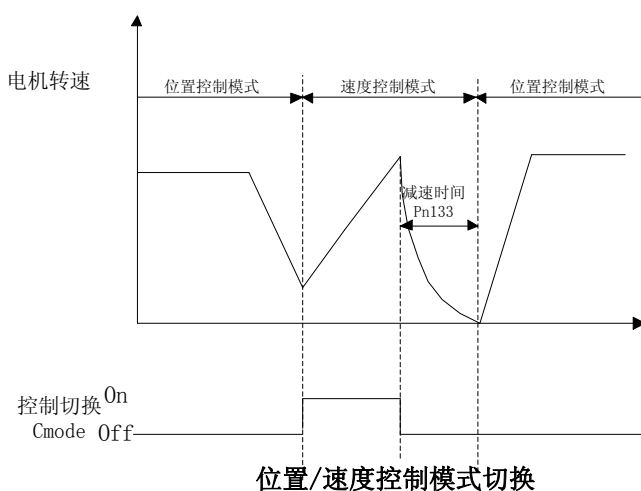

B.2 位置/转矩控制模式切换 Position / torque control mode switching

使用控制切换(cmode), 可通过输入控制端口SigIn接点进行位置控制模式和转矩控制模式的切换。cmode和控制模式的关系如下所示。Using the control switch (Cmode), the position control mode and the torque control mode can be switched by inputting the control port SigIn contact. The relationship between the Cmode and the control mode is as follows.

Cmode	控制模式control mode
OFF	位置控制模式Position control mode
ON	转矩控制模式Torque control mode

可以在零速度状态时进行控制模式的切换。但为了安全起见,请在伺服电机停止时进行切换。从位置控制模式切换到转矩控制模式时,滞留脉冲将被清除。电机使能时,切换方式有两种,时序图如下所示: The control mode can be switched at zero speed state. But to be on the safe side, switch on when the servo motor is stopped. When switching from position control mode to torque control mode, the hold pulse will be cleared. There are two modes of switching when the motor is enabled. The timing diagram is as follows:

▲Pn132=0:

只有零速度状态下,切换信号发生改变,模式切换才有效;如果不在零速度状态下,切换信号发生了改变,随后信号进入零速度状态,则不发生模式切换。Only the zero speed state, switching signal change, mode switching is effective; if not in the zero velocity state, changed switching signal, then the signal into the zero velocity state, not mode switching.

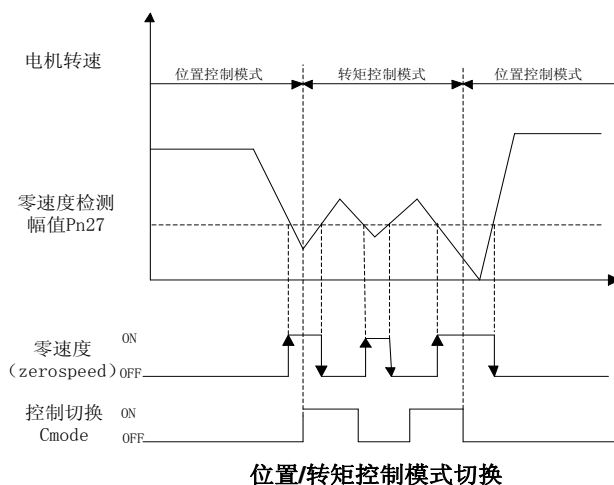

▲Pn132=1:

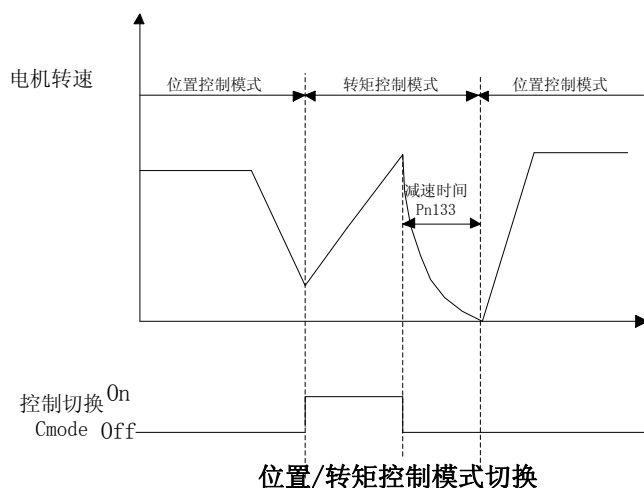

B.3 速度/转矩控制模式切换 Speed / torque control mode switching

使用控制切换(cmode), 可通过输入控制端口SigIn接点进行速度控制模式和转矩控制模式的切换。

cmode和控制模式的关系如下所示。The use of control switching (Cmode) allows the speed control mode and the torque control mode to be switched through the input control port SigIn contact. The relationship between the Cmode and the control mode is as follows.

Cmode	控制模式control mode
OFF	速度控制模式Speed control mode
ON	转矩控制模式Torque control mode

不管何时都可以进行控制模式的切换, 切换的时序图如下所示: Whenever you can control the mode of switching, the timing diagram of the switch is as follows:

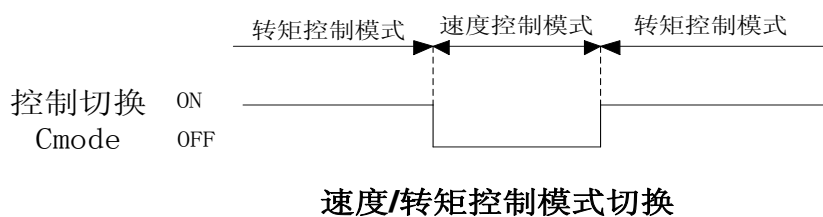

附录 C 伺服驱动器工作时序 Appendix C servo drive operation timing

C.1 电机静止时的 ON/OFF 动作时序 ON/OFF timing of motors at rest

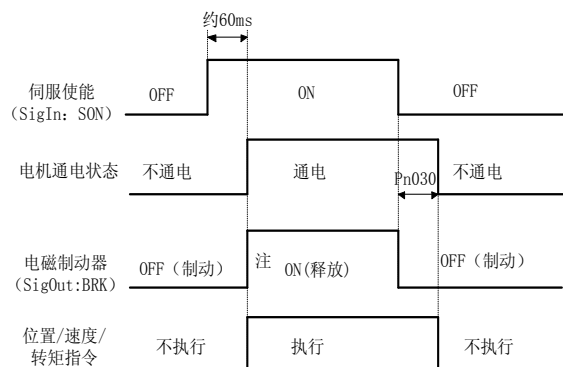

注 1: 使用电磁制动功能时, 伺服断使能方式 Pn004 必须设置为 2。

Note 1: when using the electromagnetic braking function, the servo break enable mode Pn004 must be set to 2.

注 2: 当电机转速低于参数 Pn029 时, 电磁制动器的动作时序。Note 2: when the motor speed is less than the parameter Pn029, the timing sequence of the electromagnetic brake.

C.2 电机运转时的 ON/OFF 动作时序 ON/OFF timing of motor operation

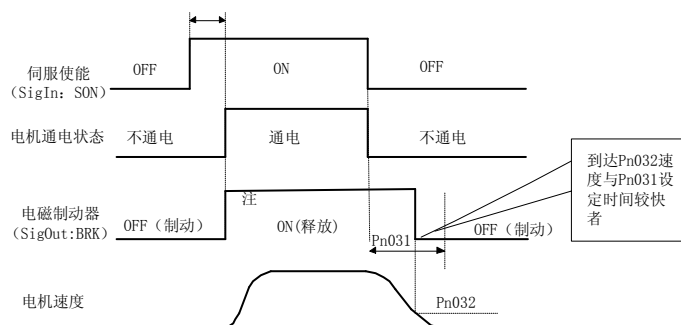

注 1: 使用电磁制动功能时, 伺服断使能方式 Pn004 必须设置为 2

Note 1: when using the electromagnetic braking function, the servo break enable mode Pn004 must be set to 2

注 2: 当电机转速不低于参数 Pn029 设定值时, 电磁制动器的动作时序。Note 2: when the motor speed is not less than the parameter Pn029 setting value, the electromagnetic brake sequence of action.

C.3 伺服 ON 时报警的时序 Timing of alarm when servo ON

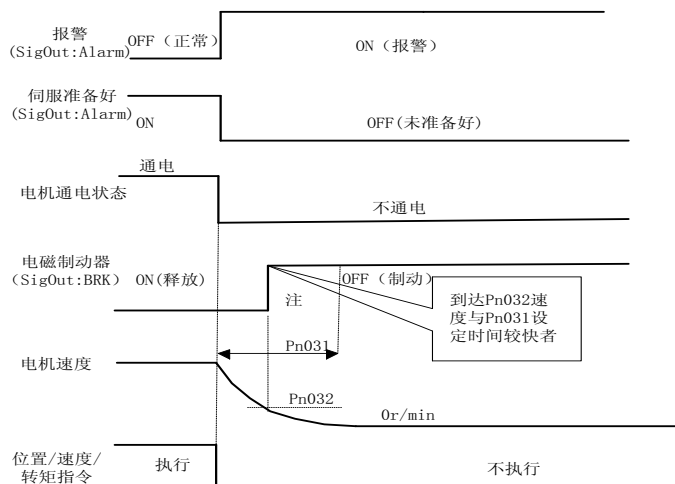

注 1: 使用电磁制动功能时, 伺服断使能方式 Pn004 必须设置为 2

Note 1: when using the electromagnetic braking function, the servo break enable mode Pn004 must be set to 2

附录 D 电磁制动器 Appendix D electromagnetic brake

电磁制动器（保持制动器、失电制动器），用于锁住与电机相连的垂直或倾斜工作台，防止伺服电源失去后工作台跌落。实现这个功能，须选购带制动器的电机。制动器只能用来保持工作台，绝不能用于减速和停止机器运动。An electromagnetic brake (holding a brake, an electric brake) used to lock a vertical or tilting table attached to the motor to prevent the bench from falling after the servo power is lost. To achieve this function, you must buy a motor with a brake. The brakes can only be used to maintain the table and must never be used to slow or stop motion.

使用电磁制动器，必须设置 Pn004 参数为 2,并在 SigOut 端口指定功能。驱动器根据电机运行的转速，依照参数 Pn029 设定值，选择相应的制动时序，执行电磁制动功能。具体时序详见附录 C。Using the electromagnetic brake, you must set the Pn004 parameter to 2 and specify the function at the SigOut port. According to the rotation speed of the motor and the setting value of the parameter Pn029, the driver selects the corresponding braking sequence and performs the electromagnetic braking function. See the appendix C for specific timing.

附录 E 再生制动电阻 Appendix E regenerative braking resistor

当伺服电机运转在发电机模式时，电能会由电机流向驱动器，称为再生电力。以下使用情况，会使伺服电机运转在发电机(再生)模式：When the servo motor running in generator mode, power flow by the

motor drive, known as renewable electricity. The following usage will cause the servo motor to operate in the generator (regenerative) mode:

(1) 伺服电机在加减速运转时，由减速到停止期间。

(1) the servo motor moves from deceleration to stop during acceleration and deceleration operation.

(2) 应用于垂直负载时。(2) when applied to vertical loads.

(3) 由负载端驱动伺服电机运转时。(3) the servo motor is operated by the load end.

此再生电力会由驱动器的主回路滤波电容吸收，但是再生电力过多时，滤波电容无法承受时，必须使用再生电阻来消耗多余的再生电能。当出现再生能量过大，内部制动电阻不能完全吸收，导致出现 AL-03(过压)、AL-08(过温)或 AL-16(制动平均功率过载)等报警。根据实际应用，增加加减速时间，若仍旧报警，就需要外接制动电阻，增强制动效果。外接制动电阻阻值范围 40~200 欧姆，功率 1000~50W，阻值越小，制动电流越大，所需制动电阻功率越大，制动能量越大，但阻值太小会可能造成损坏驱动器，试验方法是阻值由大到小，直到驱动器不再出现报警，同时运行时，制动电阻温度不太高即可。外接制动电阻时，拆去内部再生制动电阻。由于再生电阻在消耗再生电力时，会产生 100° C 以上高温，请务必小心，在连接再生电阻的电线请使用耐热不易燃的线材，并确认再生电阻没有碰触任何物品。The regeneration power absorbed by the main loop filter capacitor drive, but renewable electricity is excessive, the filter capacitor can not afford, must use recycled to consume the excess electric resistance can be recycled. When the regenerative energy is too large, the internal braking resistance can not be absorbed completely, resulting in the occurrence of AL-03 (overvoltage), AL-08 (excessive temperature) or AL-16 (braking average power overload) and other alarms. According to the actual application, increase the acceleration and deceleration time, if still alarm, need external braking resistor, enhance the braking effect. External braking resistance range 40~200 ohm, power 1000~50W, the resistance is small, the greater the braking current, required braking resistance greater power, braking energy is larger, but the resistance is too low may cause damage to the drive, the test method is resistance from large to small, drive does not appear again until the alarm, running at the same time. The temperature is not too high to brake resistance. When the external braking resistor is removed, the internal regenerative braking resistor is removed. Because the resistance in the consumption of renewable power regeneration, will produce more than 100 C high temperature, please be careful, in connection with resistance wires use heat regenerative non flammable wire, and confirm the regeneration without touching anything resistance.

注意：使用再生电阻时如果有上述报警产生，请切断电源，冷却一段时间。由于再生晶体管发生故障，再生电阻异常发热，可能会造成火灾。请务必根据应用场合，选择相匹配的制动电阻。Note: when using regenerative resistor, if the alarm is generated, please cut off the power supply and cool down for a period of time. Due to a faulty regeneration transistor, the regenerative resistor is

unusually hot and may cause a fire. Make sure to match the brake resistance according to the application.

附录 F 原点回归 Appendix F origin regression

F1.1 原点回归运行步骤 Origin regression operation step

1: 找参考点 1:Reference point

启动原点回归功能后，按原点加归第一速度寻找参考点，可使用 SigIn 输入端子 REF、CCWL 或 CWL 作为参考点，也可以 Z 脉冲作为参考点，可选择正转或反转方向寻找。Start the origin regression function, according to the first rate for the origin and the reference point, you can use the SigIn input terminal REF, CCWL or CWL as a reference point, you can also Z pulse as the reference point, can choose the forward or reverse direction finding.

2: 找原点 2: find the origin

当找到参考点后，再以第二速度寻找原点，可选择继续向前或向后折返找 Z 脉冲，也可以直接以参考点作原点。When the reference point is found, and then the second speed is used to find the origin, the Z or the pulse can be continued forward or backward, or the reference point can be used as the origin.

原点回归执行过程中，为避免速度剧烈变化造成的机械冲击，可设置参数 Pn040、Pn041 进行加减速。找到的原点加上偏移量脉冲作为实际原点，偏移量为： $Pn036*10000+Pn037$ 。In order to avoid the mechanical impact caused by the drastic change of speed, the parameter Pn040 and Pn041 can be added to reduce the speed during the execution of the origin regression. The origin is found with the offset pulse as the actual origin, and the offset is: $Pn036*10000+Pn037$.

原点回归参考点模式 (Pn034) 和原点模式 (Pn035) 有以下组合：The origin regression reference point model (Pn034) and the origin model (Pn035) have the following combinations:

Pn034 Pn035	0	1	2	3	4	5	6
0	√ (A)	√ (B)	√ (A)	√ (B)	×	×	×
1	√ (C)	√ (D)	×	×	×	×	×
2	√ (E)	√ (F)	×	×	√ (G)	√ (H)	√ (I)

其中√表示原点模式组合会正常执行,×表示原点模式组合不会执行。The √ said the origin of the model combination will perform properly, ×said the origin of the model does not perform combination .

F1.2 原点回归触发时序 Origin regression trigger timing

Pn033	原点回归触发方式 Origin regression trigger mode	0:关闭原点回归功能 Turn off the origin regression function 1: 由 SigIn 输入的 GOH 电平触发 Triggered by the GOH level input by the SigIn 2: 由 SigIn 输入的 GOH 边沿触发 GOH edge triggered by SigIn input 3: 上电自动执行一次 Power up automatically once
-------	--	---

● 电平触发 (Pn033=1) Level triggered (Pn033=1)

伺服使能后,输入端子 GOH 触发原点回归执行,GOH 上边沿开始回归操作,暂停正常指令执行,下边沿结束回归操作。GOH 一直保持 ON,回归执行完后,位置偏差清零(位置控制),输出端子 HOME 变为 ON。直到 GOH 变为 OFF,则 HOME 变为 OFF。After servo enable, the input terminal GOH triggers the origin return execution, and the GOH starts the return operation on the top side, stops the normal instruction execution, and the lower edge ends the return operation. GOH keeps ON, and when the execution is complete, the position offset is cleared (position control), and the output terminal HOME becomes ON. Until GOH becomes OFF, then HOME becomes OFF.

当 Pn044=0 时,原点回归完成后等待 GOH 信号变为 OFF 后再执行指令,等待期间电机停留在原点,不接受指令;当 Pn044=1 时,原点回归完成后立刻执指令。When Pn044=0, when the origin return is complete, wait for the GOH signal to change to OFF and then execute the instruction. During the waiting period, the motor stays at the origin and does not accept the instruction. When the Pn044=1 is returned, the command is executed immediately after the origin return is completed.

在原点回归执行中,如果取消伺服使能 son、产生任何报警、GOH 提前变为 OFF,则原点回归功能中止且输出端子 HOME 不动作。此外,如果使能 son 有效、没有报警,回归在执行中且没有完成,即使边沿触发 (Pn033=2)信号重复有效,则驱动器会完成当前回归操作后,再检测边沿触发信号。In origin return execution, if the servo is enabled, the son is enabled, any alarm is generated, and the GOH is advanced to OFF, the origin regression function is aborted and the output terminal HOME is not operative. In addition, if the son effective, no alarm, return in the execution and no complete, even if the edge triggered (Pn033=2) signal repetition effectively, the drive will return after completion of the current operation, then the trigger signal edge detection.

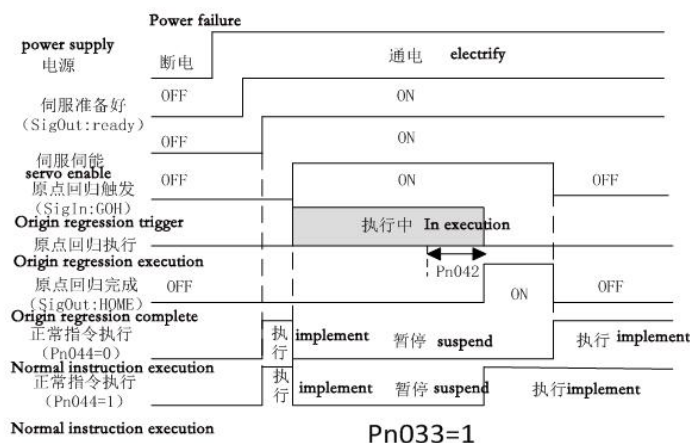

● 边沿触发 (Pn033=2) Edge triggered (Pn033=2)

伺服使能后，输入端子 GOH 上升触发原点回归执行，并暂停正常指令执行 After servo enable, the input terminal GOH rises, triggers the origin return execution, and pauses the normal instruction execution

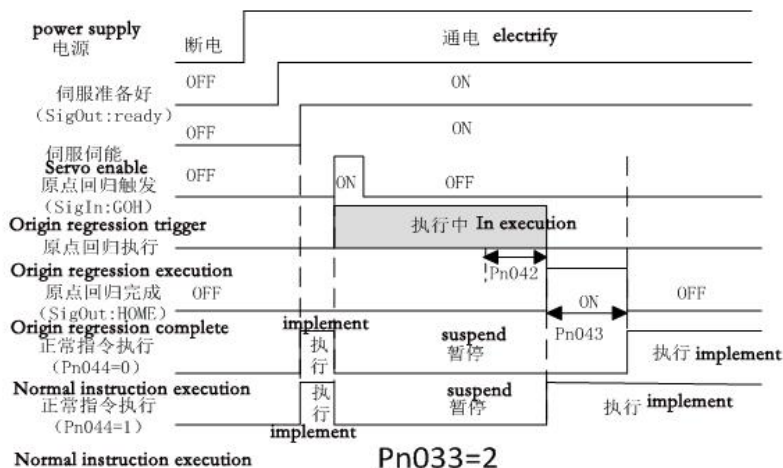

● 上电自动执行 (Pn033=3) Power on automatic execution (Pn033=3)

此功能仅于上电后伺服初次使能有效时执行一次，以后不需要重复运行原点回归的情况。每次上电，驱动器自动执行一次原点回归操作。使用此功能可以节省一个输入端子 GOH。
This function is only performed once the power is on, the servo is first valid, and then the origin return is not repeated. Each time the power is turned on, the drive automatically performs an origin return operation. With this feature, you can save an input terminal GOH.

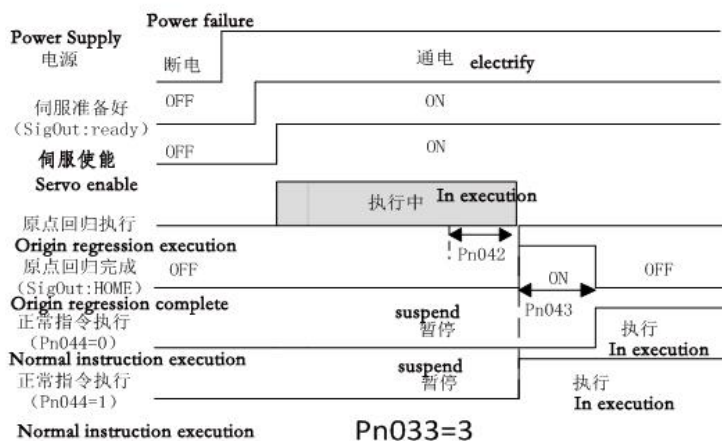

F1.3 原点回归组合模式时序 Origin regression, combination model, time series

Pn034	原点回归参考点模式 Origin regression reference point mode	<p>0:正转找 REF(上升沿触发)作参考点 0:The REF is turned (triggered by the rising edge) as the reference point</p> <p>1:反转找 REF(上升沿触发)作参考点 1: reverse, find REF (rising edge trigger) as reference point</p> <p>2:正转找 CCWL(下降沿触发)作参考点 2: is turning to CCWL (triggered by the falling edge) as the reference point</p> <p>3:反转找 CWL(下降沿触发)作参考点 3: reverse for CWL (falling edge triggered) for reference</p> <p>4:正转找 Z 脉冲作参考点 4: is looking for the Z pulse as the reference point</p> <p>5:反转找 Z 脉冲作参考点 5: reverses the Z pulse for reference points</p> <p>6:绝对零点作参考点(仅绝对式编码器有效) 6: absolute zero as reference point (valid only for absolute encoder)</p>	0~6	0
Pn035	原点回归原点模式 Origin regression origin mode	<p>0: 向后找 Z 脉冲作原点 0: back to the Z pulse as the origin</p> <p>1: 向前找 Z 脉冲作原点 1: look for the Z pulse as the origin</p> <p>2: 直接以参考点上升沿作原点 2: take the rising edge of reference point as the origin directly</p>	0~2	0

注 1: 通过组合参数 Pn034 和 Pn035, 有 8 种可用的原点回归方式。Note 1: by combining parameter Pn034 and Pn035, there are 8 available origin return methods.

注 2: 在零点回归操作时, 将关闭正/反驱动禁止功能, 直至退出回归操作。Note 2: when the origin returns operation, the positive / reverse drive disable is turned off until the regression operation is exited.

(A)Pn034=0 或 2,Pn035=0

参数 parameter	设定 Setting	说明 instruction
Pn034	0 或 2	原点回归启动后, 按回归第一速度正转找 REF(上升沿触发)或 CCWL(下降沿触发)作参考点 After the origin regression starts, the first speed is turned to REF (rising edge triggered) or CCWL (triggered by the falling edge) as the reference point
Pn035	0	到达参考点后, 按回归第二速度向后找 Z 脉冲作原点 After arriving at the reference point, the Z pulse is returned to the origin at the second speed of the return

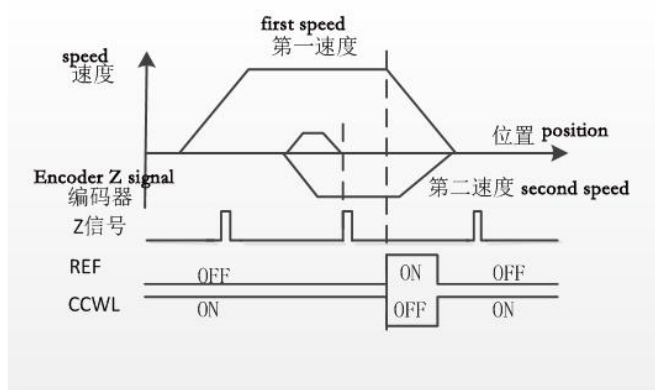

(B)Pn034=1 或 3,Pn035=0

参数 parameter	设定 Setting	说明 instruction
Pn034	1 或 3 1 or 3	原点回归启动后, 按回归第一速度反转找 REF (上升沿触发) 或 CWL(下降沿触发)作参考点 After the origin regression is started, the first speed inversion is used to find the REF (rising edge triggered) or CWL (triggered by the falling edge) as the reference point
Pn035	0	到达参考点后, 按回归第二速度向后找 Z 脉冲作原点 After arriving at the reference point, the Z pulse is returned to the origin at the second speed of the return

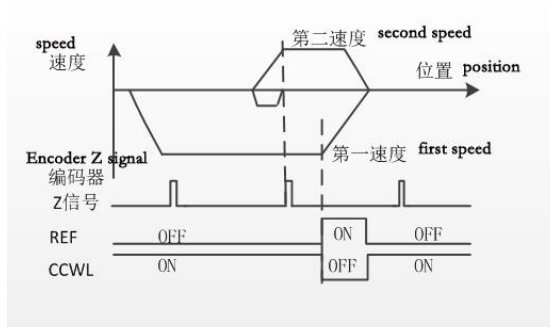

(C)Pn034=0,Pn035=1

参数 parameter	设定 Setting	说明 instruction
Pn034	0	原点回归启动后，按回归第一速度正转找 REF(上升沿触发)作参考点 After the origin of the regression start, the first speed is transferred to the REF (rising edge trigger) as the reference point
Pn035	1	到达参考点后，按回归第二速度向前找 Z 脉冲作原点 After arriving at the reference point, forward the Z pulse at the return second speed as the origin

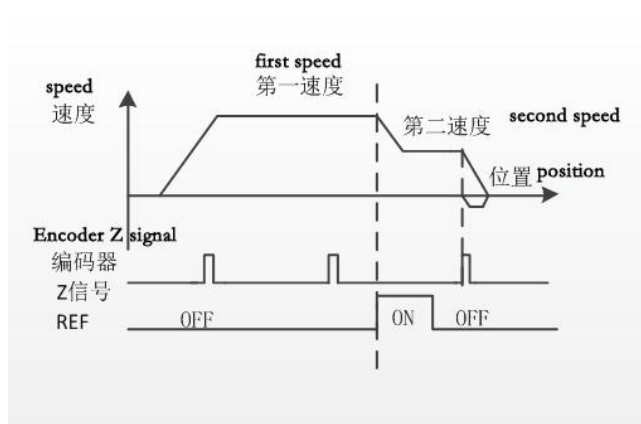

(D)Pn034=1,Pn035=1

参数 parameter	设定 Setting	说明 instruction
Pn034	1	原点回归启动后，按回归第一速度反转找 REF(上升沿触发)作参考点 After the origin regression starts, the REF (rising edge trigger) is used as the reference point according to the first speed inversion of the regression

Pn035	1	到达参考点后, 按回归第二速度向前找 Z 脉冲作原点 After arriving at the reference point, forward the Z pulse at the return second speed as the origin
-------	---	--

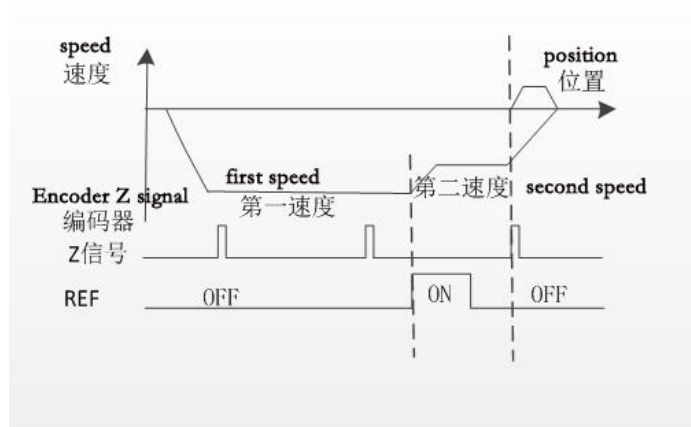

(E)Pn034=0,Pn035=2

参数 parameter	设定 Setting	说明 instruction
Pn034	0	原点回归启动后, 按回归第一速度正转找 REF(上升沿触发)作参考点 After the origin of the regression start, the first speed is transferred to the REF (rising edge trigger) as the reference point
Pn035	2	到达参考点后, 直接以参考点作为原点 When the reference point is reached, the reference point is used as the origin point

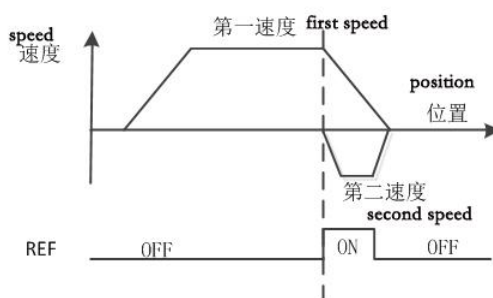

(F)Pn034=1,Pn035=2

参数 parameter	设定 Setting	说明 instruction
Pn034	1	原点回归启动后, 按回归第一速度反转找 REF(上升沿触发)作参考点 After the origin regression starts, the REF (rising edge trigger) is used as

		the reference point according to the first speed inversion of the regression
Pn035	2	到达参考点后，直接以参考点作为原点 When the reference point is reached, the reference point is used as the origin point

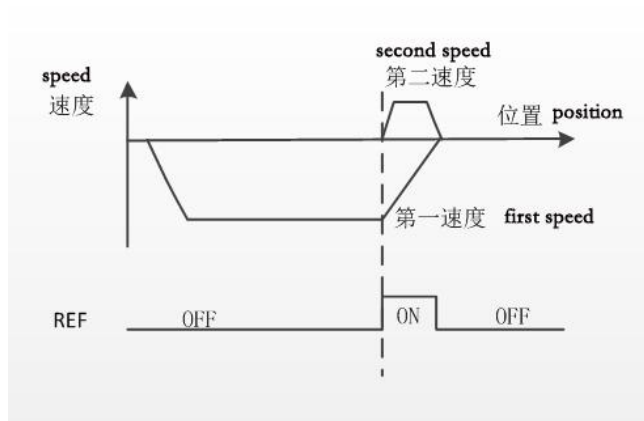

(G)Pn034=4,Pn035=2

参数 parameter	设定 Setting	说明 instruction
Pn034	4	原点回归启动后，按回归第一速度正转找 Z 脉冲作参考点 After the origin regression starts, the Z pulse is turned to the reference point according to the first speed of the regression
Pn035	2	到达参考点后，直接以参考点作为原点 When the reference point is reached, the reference point is used as the origin point

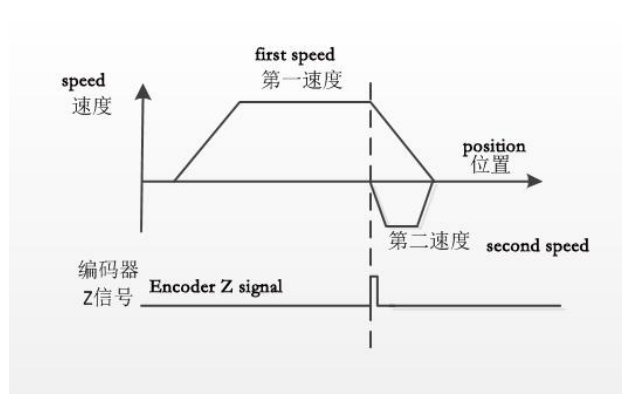

(H)Pn034=5,Pn035=2

参数 parameter	设定 Setting	说明 instruction
Pn034	5	原点回归启动后, 按回归第一速度反转找 Z 脉冲作参考点 After the origin regression is started, the Z pulse is selected as the reference point according to the first speed reversal of the regression
Pn035	2	到达参考点后, 直接以参考点作为原点 When the reference point is reached, the reference point is used as the origin point

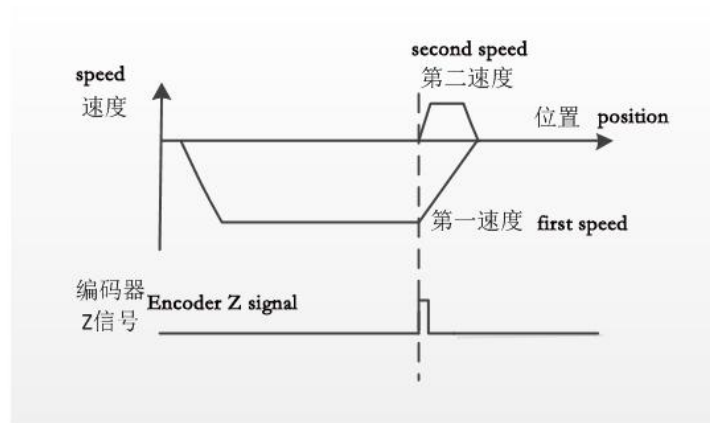

(I)Pn034=6,Pn035=2

参数 parameter	设定 Setting	说明 instruction
Pn034	6	绝对值电机绝对零点作为参考点 The absolute zero of the absolute motor is used as the reference point
Pn035	2	到达参考点后, 直接以参考点作为原点 When the reference point is reached, the reference point is used as the origin point

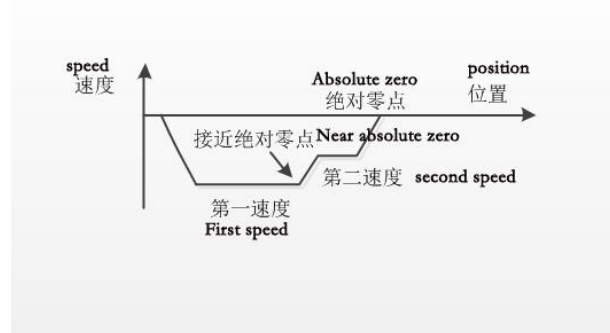

附录 G 内部位置控制 Appendix G internal position control

进行内部位置控制，需设置 Pn002=2, Pn117=1, 以及在 Pn118~Pn131 设置相应的运行参数。SigIn 端口的 pos1, pos2 选择内部位置指令 N: For internal position control, you need to set Pn002=2, Pn117=1, and set the corresponding running parameters in Pn118~Pn131. The SigIn port pos1, pos2 selects the internal location command N:

Pos2	Pos1	内部位置指令 NInternal location command N
Off	Off	内部位置指令 0Internal location command 0
Off	On	内部位置指令 1Internal location command 1
On	Off	内部位置指令 2Internal location command 2
On	On	内部位置指令 3Internal location command 3

使用内部位置控制时，先确定输入端口 pos1, pos2 的状态，即选择相应的内部位置指令，然后触发输入信号 ptriger，每次 ptriger(OFF->ON)下降沿时，驱动器读取内部位置指令 N，累加至剩余的指令脉冲数，继续执行相应的操作。The use of internal position control, first determine the input port pos1, pos2 state, choose the corresponding internal position command, and then trigger input signal ptriger, each ptriger (OFF->ON) decreased when the driver reads the internal position command N, accumulated to the remaining instruction pulse number, to continue the implementation of the corresponding operation.

如果设置 Pn118=0, 在位置移动过程中想暂停电机运行，当触发输入端口 pstop 信号，电机减速停止，然后驱动器自动清除剩余位置指令，当输入端口 ptriger 再次触发时，驱动器会根据当前 pos1, pos2 的状态，执行相应的位置指令，请参考以下时序图: If you set the Pn118=0, want to pause the motor running in the location process, when the trigger input pstop signal, motor deceleration stop, then drive automatically remove the remaining position command, when the input port of the ptriger trigger, the driver will be based on the current state of pos1, pos2, executive position instruction, please refer to the following sequence diagram:

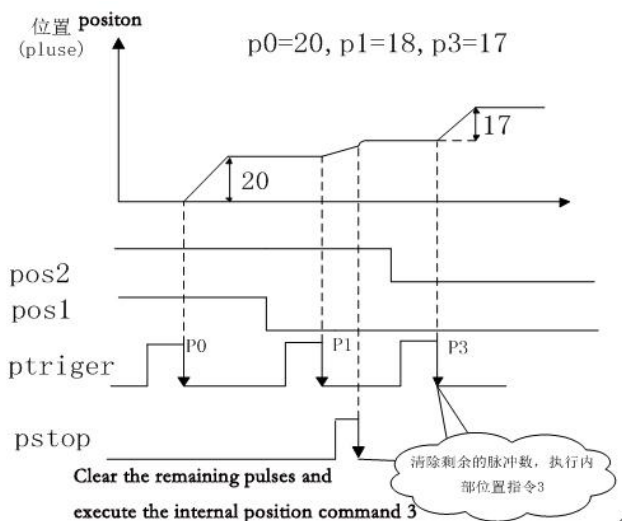

如果设置 Pn118=1,在位置移动过程中暂停电机运转,当触发输入端口 pstop 信号,电机减速停止,当输入端口 ptriger 再次触发时,电机会继续走完剩余的位置指令,到达输入端口 pstop 触发前所下达的目标位置,请参考以下时序图: If you set the Pn118=1, suspension of motor running in the location process, when the trigger signal input port pstop, motor deceleration stop, when the input port of the ptriger trigger, the motor will continue to walk the remaining position command, arrived at the input port pstop trigger issued before the target position, please refer to the following sequence diagram:

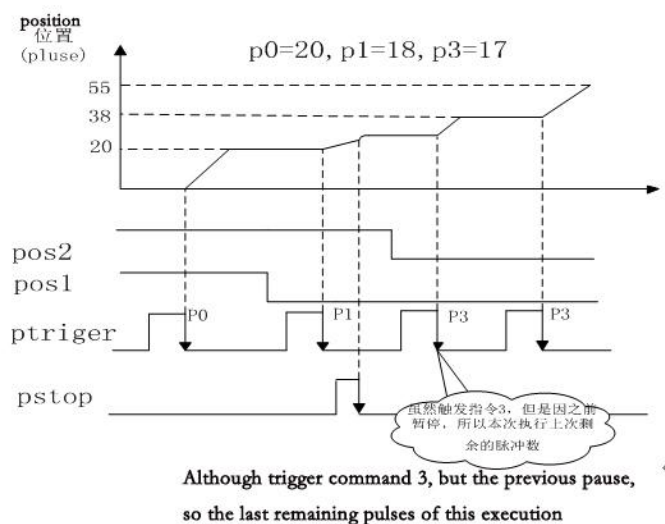

附录 H 定长位移中断 Appendix H fixed length displacement interruption

定长位移相关参数如下: The parameters of fixed length displacement are as follows:

Pn134	定长位移方向 Fixed length displacement direction	0~1	0		P
Pn135	定长位移高位 Fixed length shift height	0~9999	0	万个 Tens of thousands	P
Pn136	定长位移低位 Fixed length shift low	0~9999	100	个	P
Pn137	定长最高运行速度 Maximum running speed at fixed length	5~5000	200	r/min	P
Pn138	定长锁定解除方式 Fixed length locking release	0~1	1		P

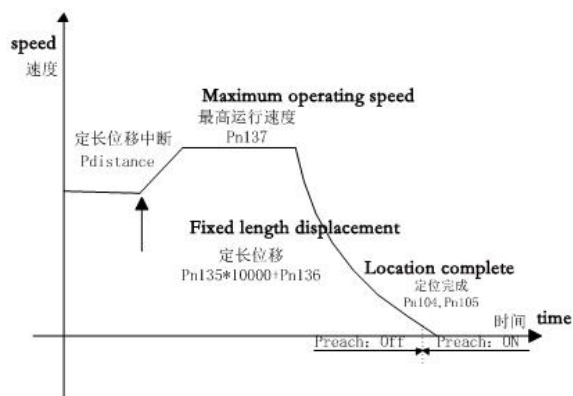

定长位移中断是指电机在位置控制模式下处于运行或停止状态，输入端口信号SigIn: Pdistance边沿有效时，电机将按原先速度方向 (Pn134) 移动特定的距离 (Pn135*10000+Pn136)。在定长位移执行过程中，伺服处于定长位移锁定状态，将无视其它位置指令（包括Pdistance和Punlock触发信号）。当完成定长距离，符合定位完成条件 (Pn104, Pn105) 后，SigOut: Preach端口信号输出变为0n状态。此后，驱动器根据锁定解除方式 (Pn138) 的设定，执行相应的解锁方式。若Pn138为0，则定位完成后立即响应位置指令；若Pn138为1，只有在输入端口SigIn: Punlock信号边沿有效后，才会解除锁定状态，响应位置指令。SigIn: Pdistance、Punlock及SigOut: Preach端口信号需在Pn052~Pn063等参数中作相应设置。

Fixed length displacement discontinuity refers to the motor is in stop mode or in position control mode, the SigIn:Pdistance input signal edge effectively, the motor will speed according to the original direction (Pn134) mobile specific distance (Pn135*10000+Pn136). During the execution of fixed displacement,

The servo is in a fixed length shift lock position and will ignore other position instructions (including Pdistance and Punlock trigger signals). When the fixed length is completed After the distance meets the position completion condition (Pn104, Pn105), the SigOut: Preach port signal output changes to 0n state. Thereafter, the drive performs the corresponding unlock mode in accordance with the setting of the lock release (Pn138) method. If Pn138 is 0, the position response is immediately answered after completion of the position; if Pn138 is 1, the lock state is unlocked only after the input port SigIn:Punlock signal edge is valid, in response to the position command. The port signals of SigIn:Pdistance, Punlock and SigOut:Preach should be set in Pn052~Pn063 and other parameters.

注1：定位完成参数Pn104, Pn105设置越大，Preach信号越提前变为0n状态，但并不影响锁定状态下的最终定位精度。若在preach信号变为0n状态时，得到较小的定长位移误差，可减小Pn104, Pn105参数值或等待电机静止。

Note 1: position completion parameter Pn104, the greater the Pn105 setting, the earlier the Preach signal becomes the 0n state, but does not affect the final positioning accuracy in the locked state. If the preach signal changes to the 0n state, a smaller fixed displacement error is obtained, which reduces the Pn104, Pn105 parameter values, or waits for the motor to remain stationary.

注2：位置指令加减速方式 (Pn109) 必须设置为0。

Note 2: position command acceleration / deceleration (Pn109) must be set to 0.

